

DRAGON BLOK

**FIREBOAT/
BATEAU DE
POMPIER**

79 PCS

6+

FIRE RESCUE

1 OF /
DE 8



Imports
DRAGON

1

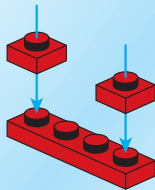
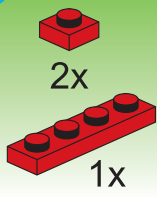

2

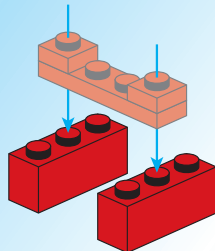
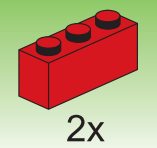

3

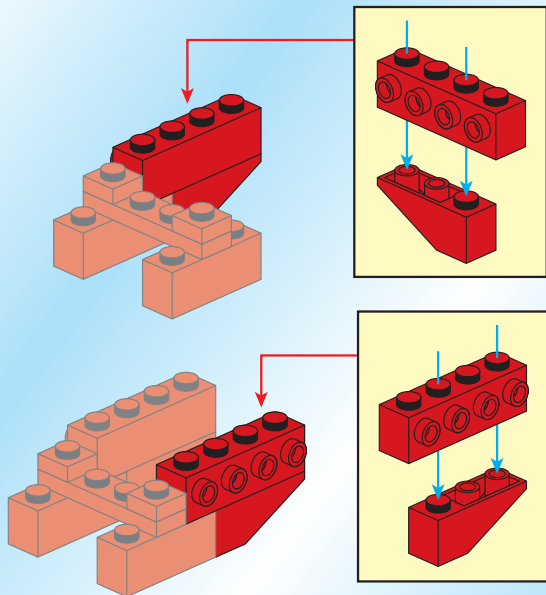
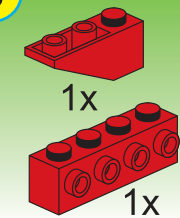

4

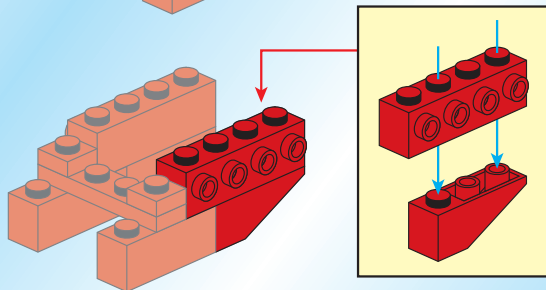
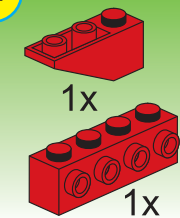

5

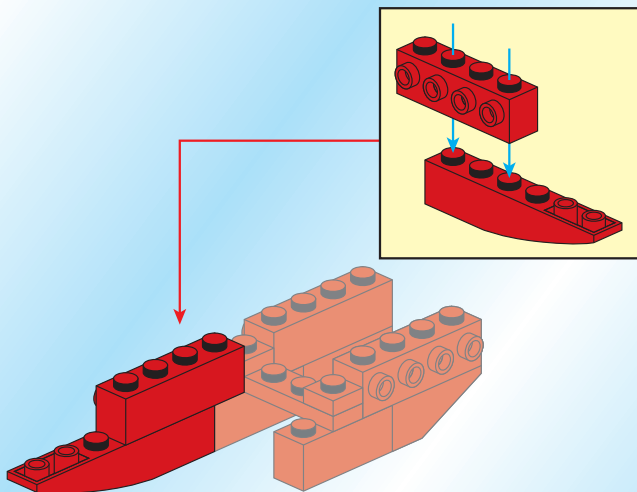
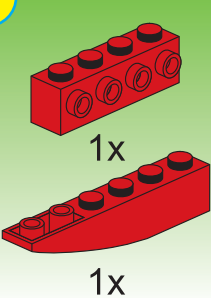

6

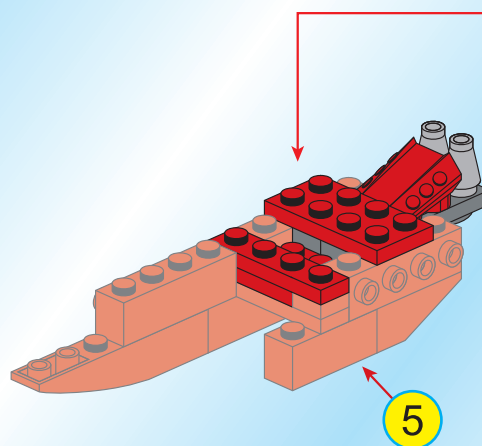
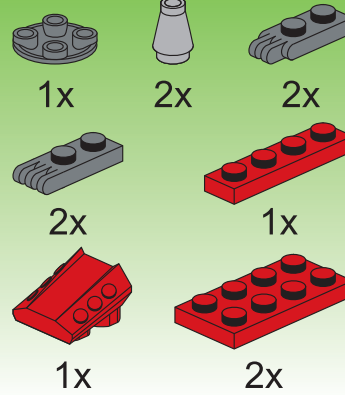

1

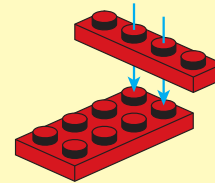

2

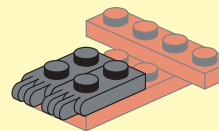

3

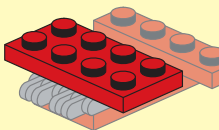

1

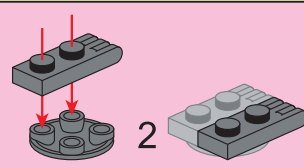

4

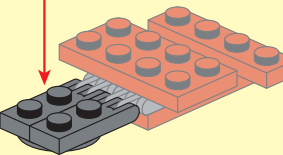

5

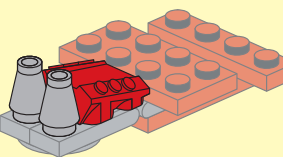

7

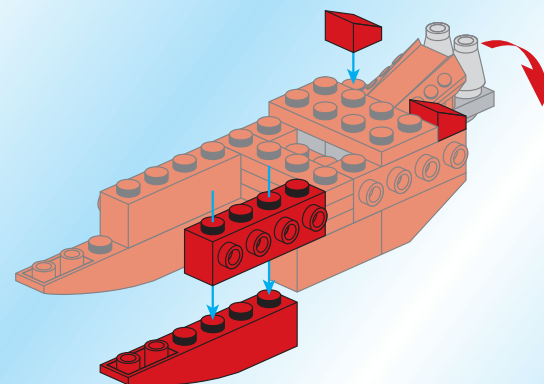
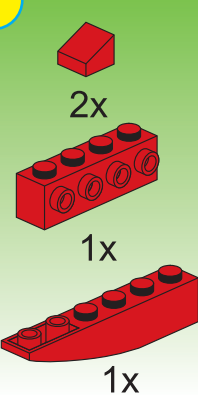

8

