

6  
1x

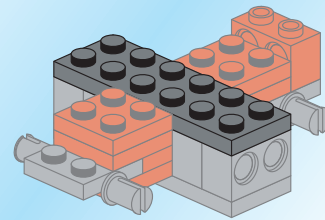

7  
1x  
1x

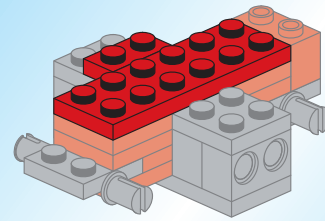

1  
1x  
1x

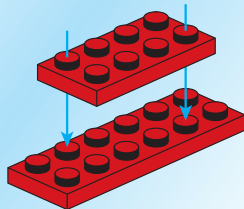

2  
2x

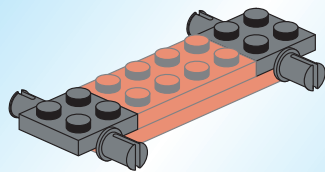

3  
1x

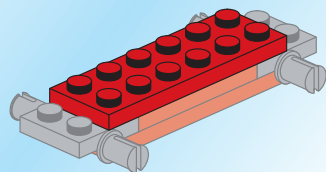

4  
2x  
1x

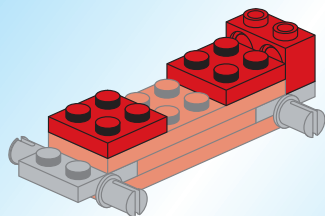

5  
2x  
2x  
1x

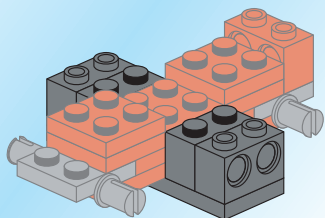

1 2

8  
1x  
1x

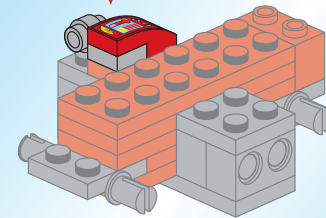
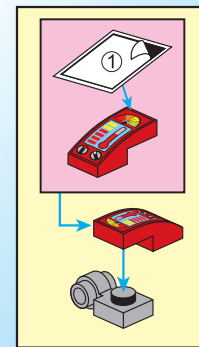

9  
2x  
1x

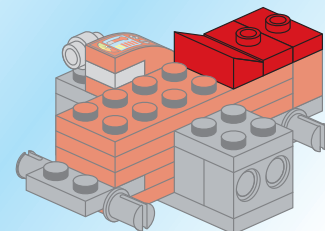

10  
2x  
1x

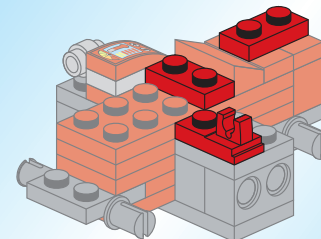

11  
1x  
1x

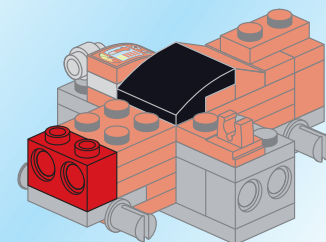

12  
1x  
1x  
1x

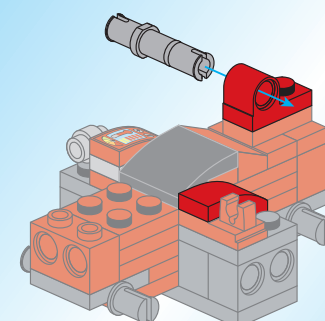

13

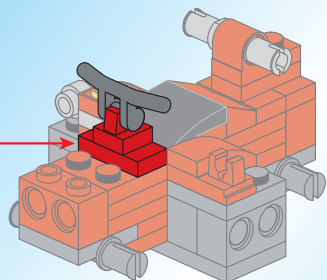
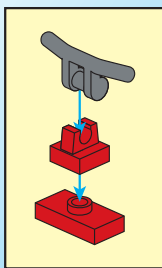
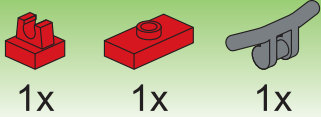

17

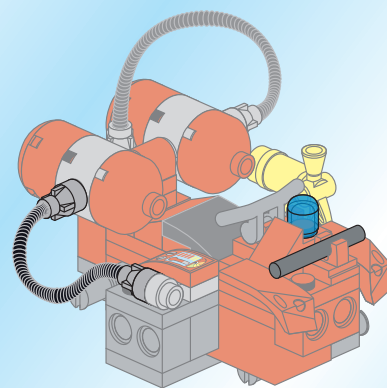
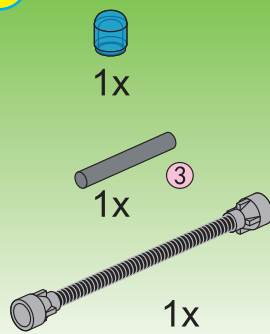

14

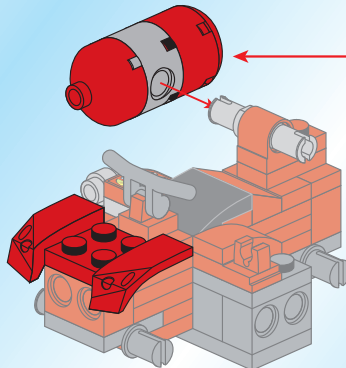
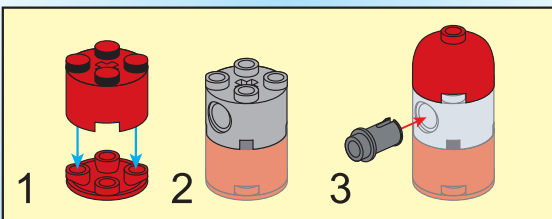
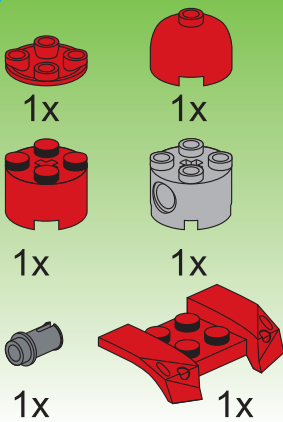

18

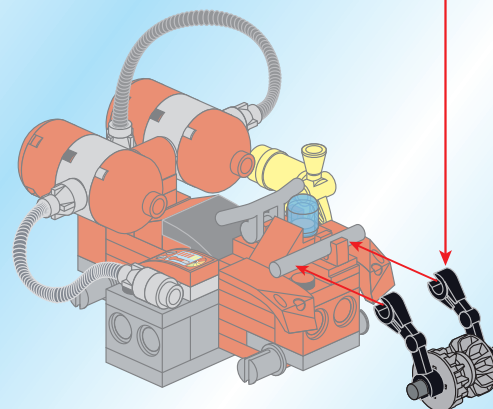
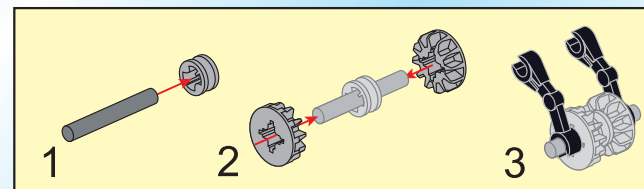
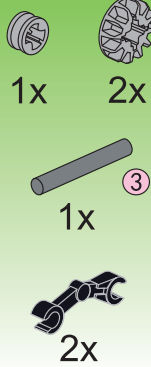

15

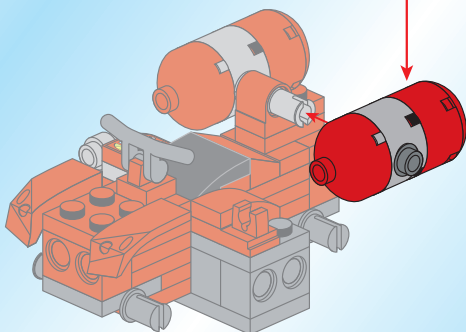
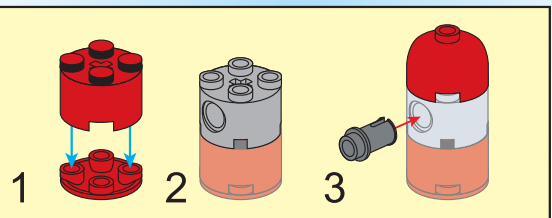
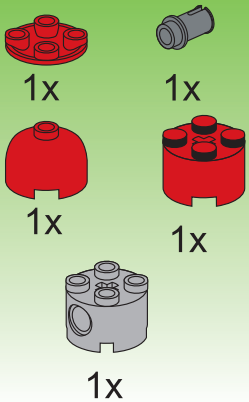

19

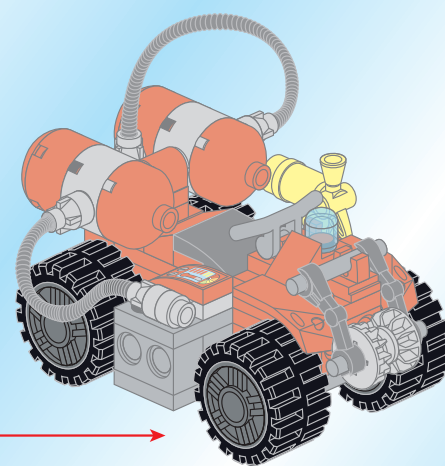
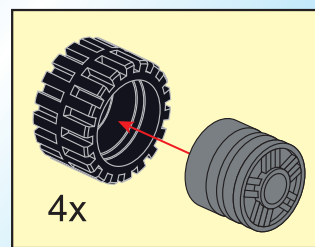
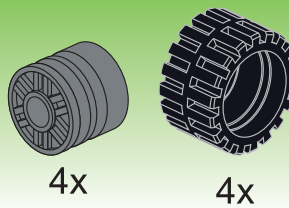

16

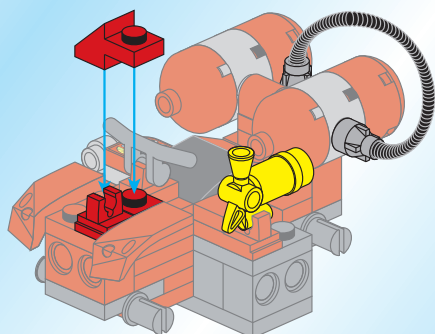
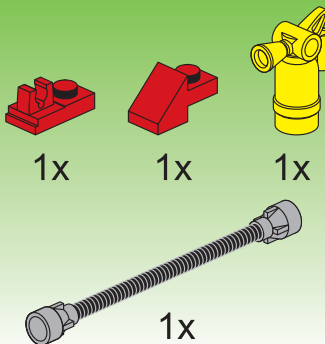

20

