



**7**

- 1x
- 1x
- 2x
- 2x
- 2x
- 1x
- 1x
- 1x
- 1x
- 1x
- 1x

1

2

3

4

5

6

**1**

- 1x
- 1x

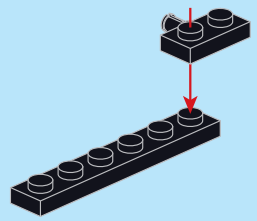

**2**

- 3x

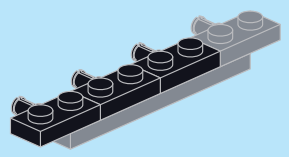

**3**

- 2x
- 1x

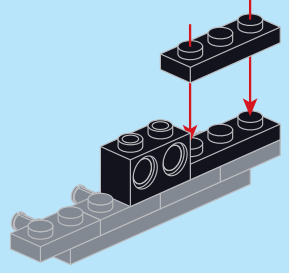

1

2

**4**

- 1x
- 1x
- 1x

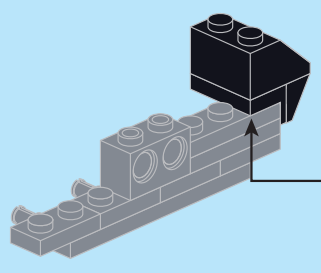

**5**

- 1x
- 2x

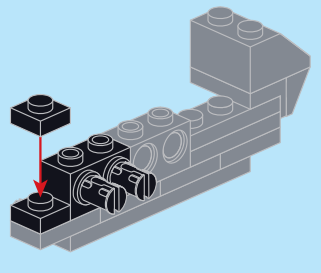

1

2

**6**

- 1x
- 1x
- 1x

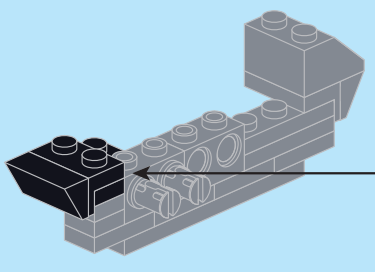

**8**

- 1x
- 1x
- 1x
- 1x

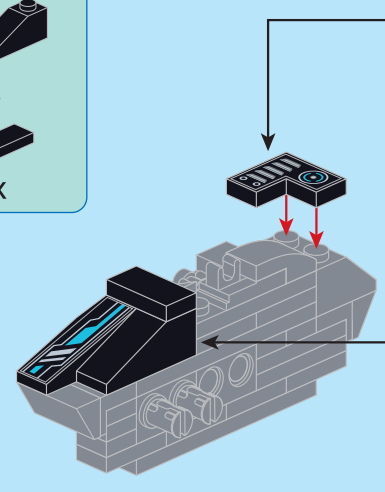

3

1

**9**

- 1x
- 1x
- 1x
- 1x
- 1x
- 1x

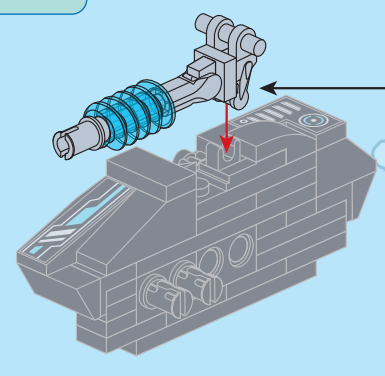

1

2

3

10

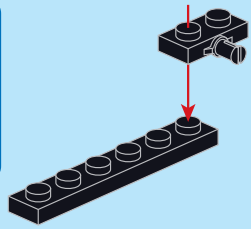
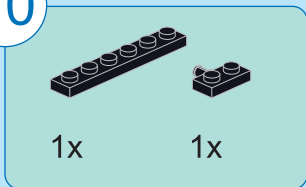

11

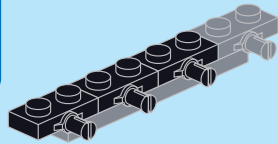
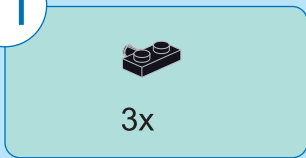

12

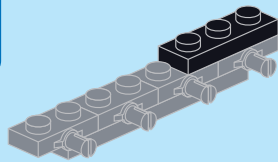
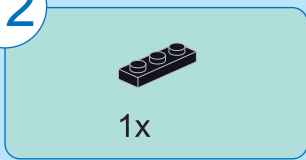

13

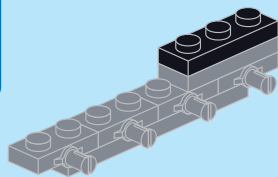
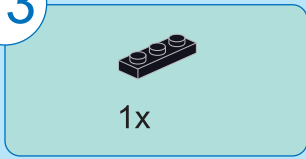

14

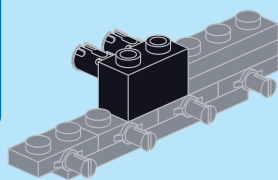
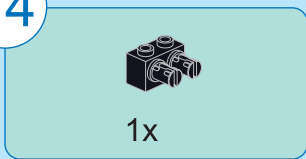

15

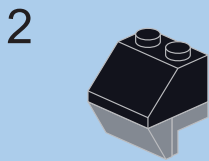
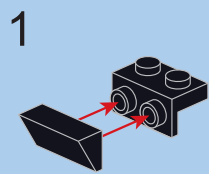
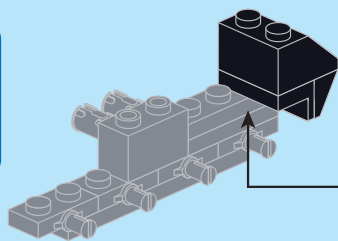
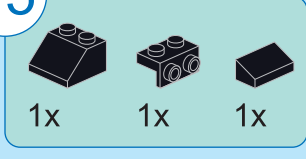

16

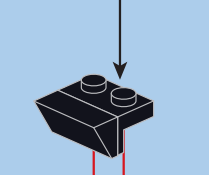
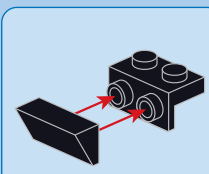
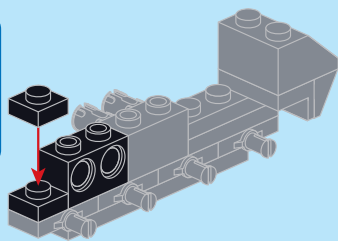
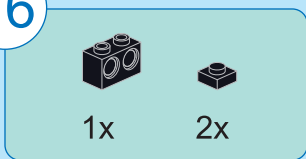

17

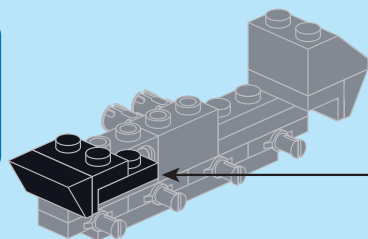
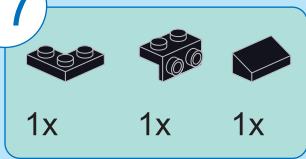

18

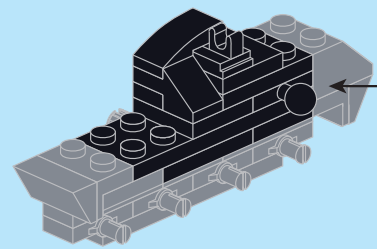
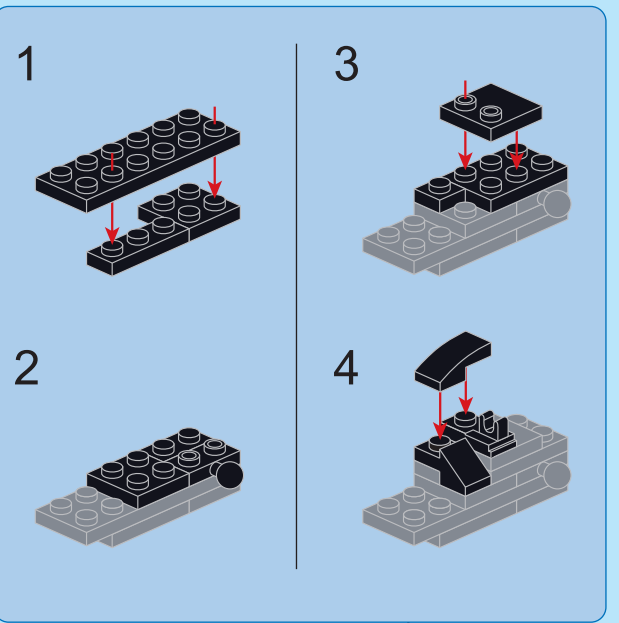
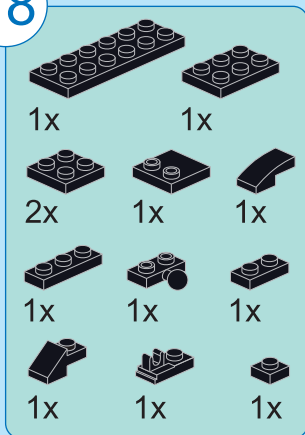

19

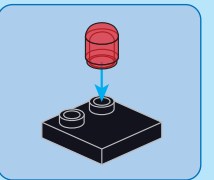
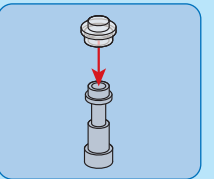
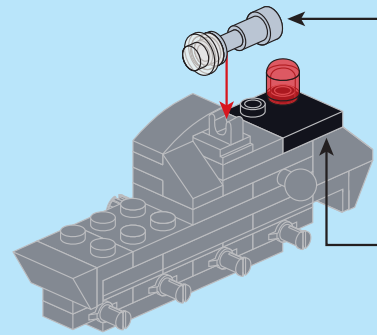
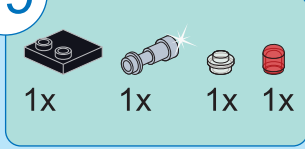

20

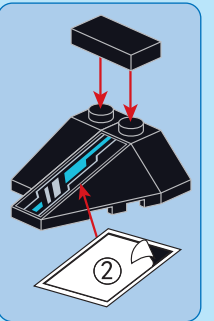
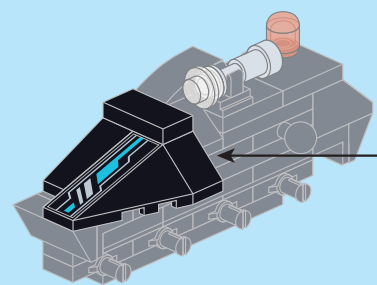
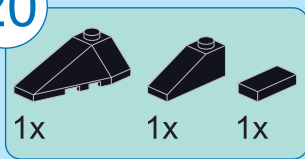

21

9

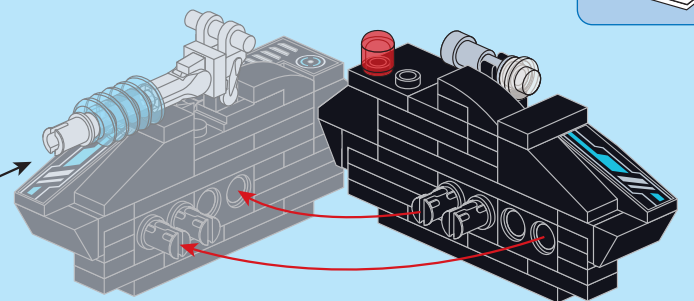

22

