

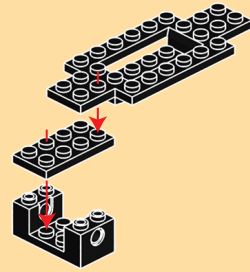

1

x1 x1 x1



2

x1 x1 x1

3

x1 x1 x1 x4

4 1x6

x2 x6 x6

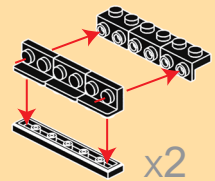
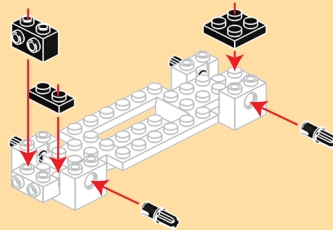
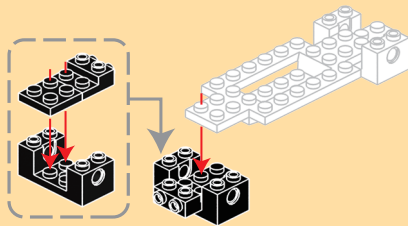

5

x1 x1 x2

6 3 + 5

7

x1 x1

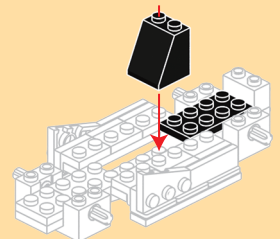
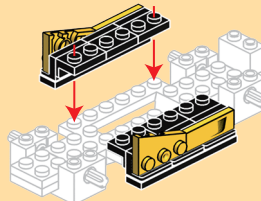
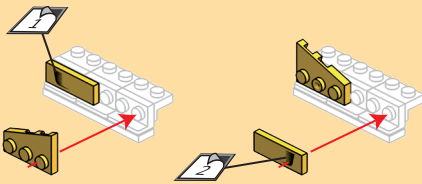

8

x6 x2 x2 x2

9

x1 x1 x2 x2

10 7 + 9

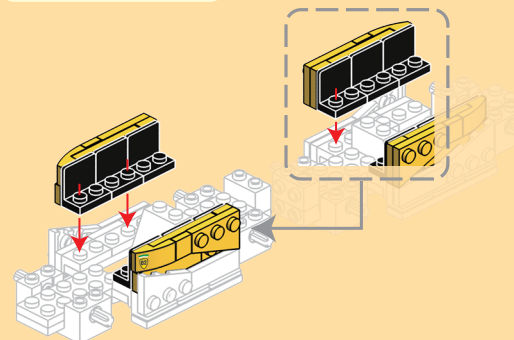
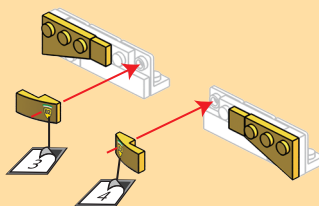
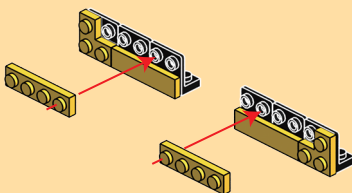

- 11

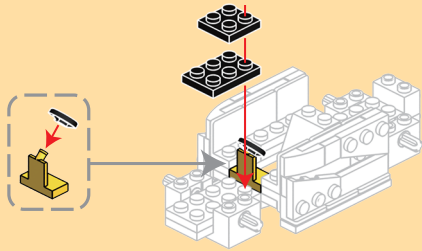
 x1 x1 x1 x1

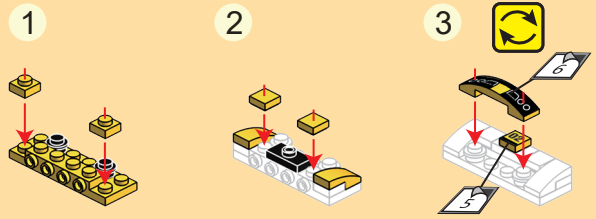

- 12

 x1 x1 x2 x1 x2 x3 x2

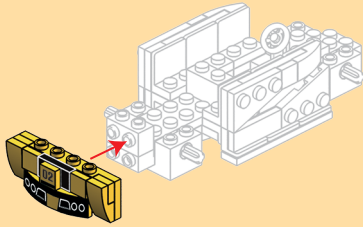

- 13 11 + 12

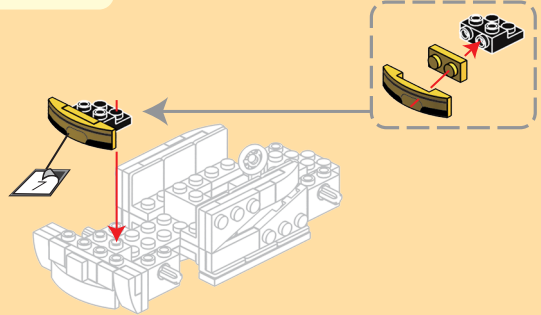

- 14

 x1 x1 x1

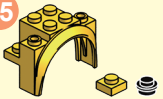

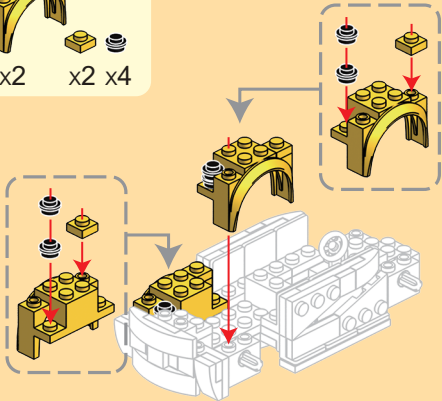
- 15

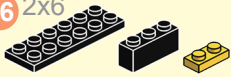
 x2 x2 x4

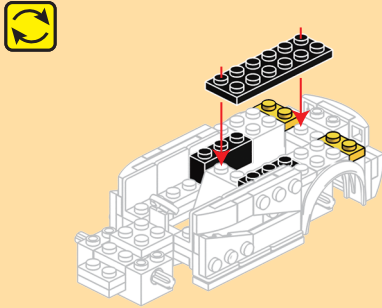

- 16 2x6

 x1 x2 x2

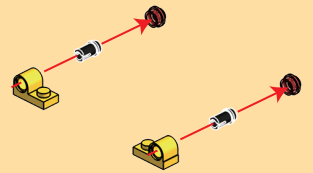

- 17

 x2 x2 x2

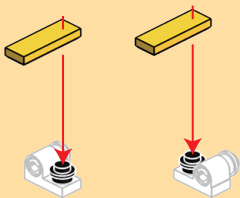

- 18 1x3

 x2 x2

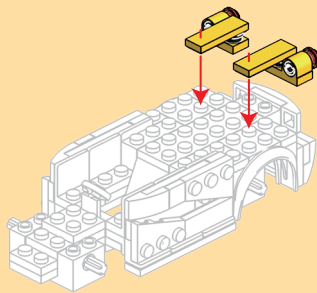

- 19 16 + 18

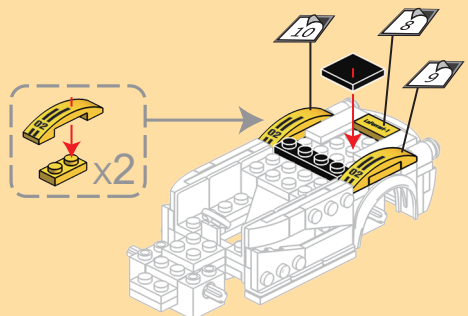

- 20

 x2 x1 x1 x2 x1

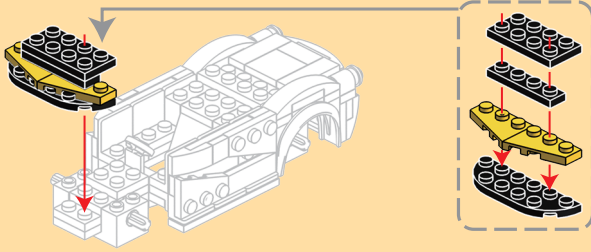

- 21
- x1
 - x1
 - x1
 - x1
 - x1

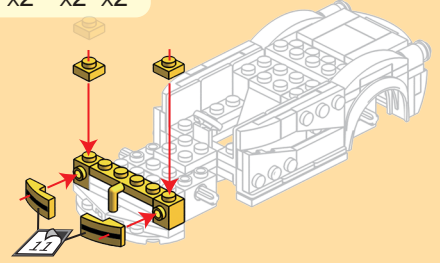

- 22
- x1
 - x2
 - x2
 - x2



- 23
- x2
 - x2

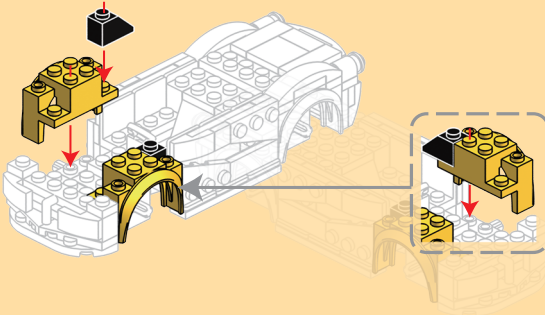

- 24
- x1
 - x1
 - x2
 - x2

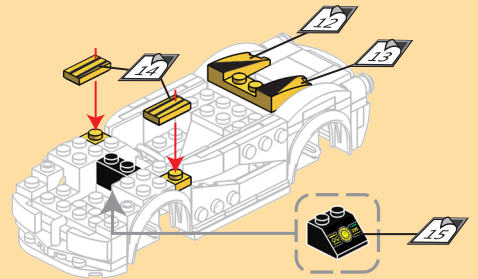

- 25
- x1
 - x2

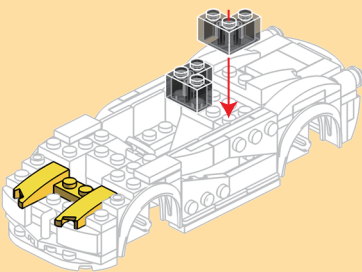

- 26
- 1x4
 - x1
 - x1

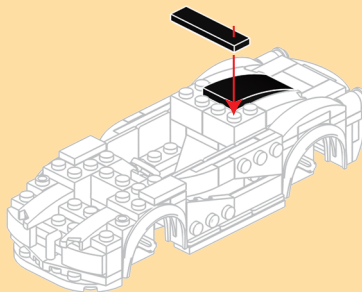

- 27
- x1
 - x1
 - x2

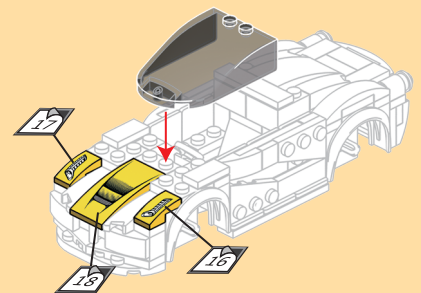

- 28
- x4
 - x4
 - x4

