



THE CN TOWER LA TOUR CN

Canada

The world's greatest architectural designs /

Les plus grandes œuvres architecturales du monde

10+



Creativity



Créativité

Family
Interaction



Interaction
familiale

Observation



Observation

Reasoning



Raisonnement

Fine motor
skills



Motricité
fine

424 PCS

1 10 X 10

x4 x12

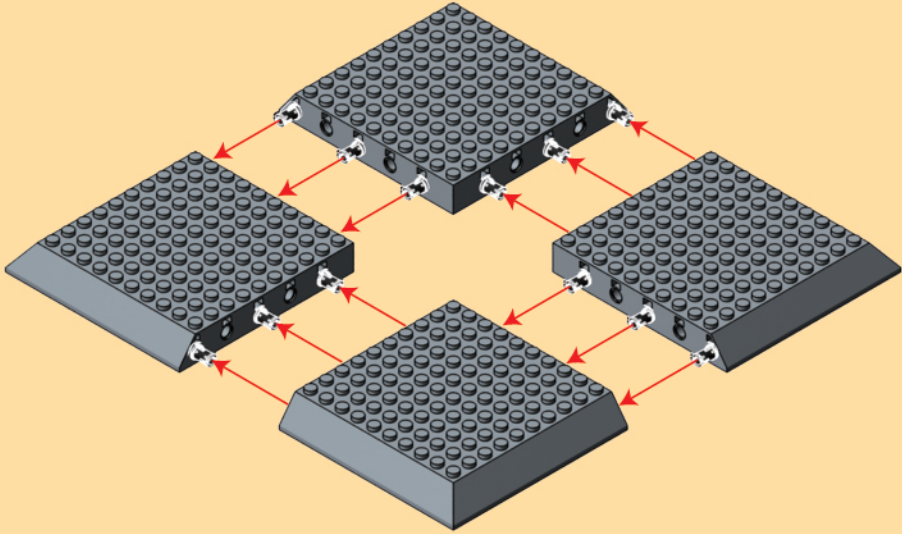



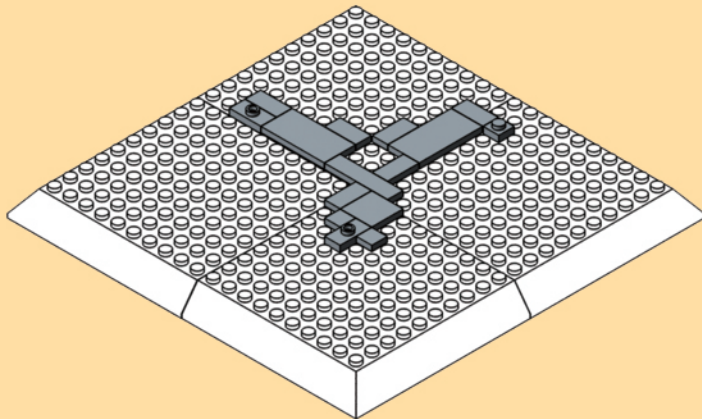

2

x2 x1 x1 x2 x6 x1 x2





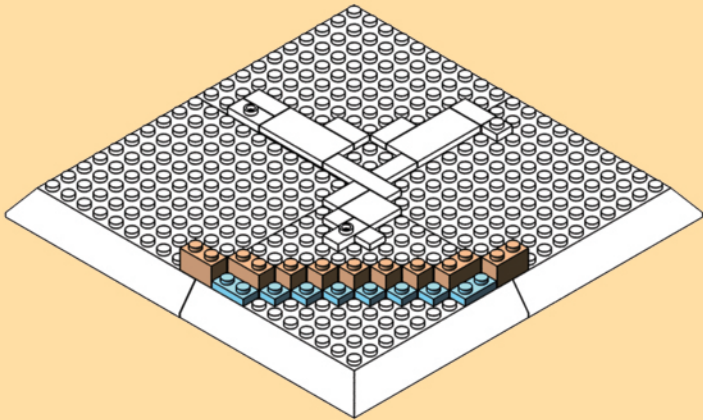

3

			
x4	x5	x2	x6

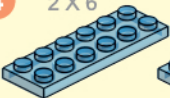
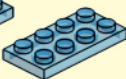

4

				
x1	x1	x1	x1	x3

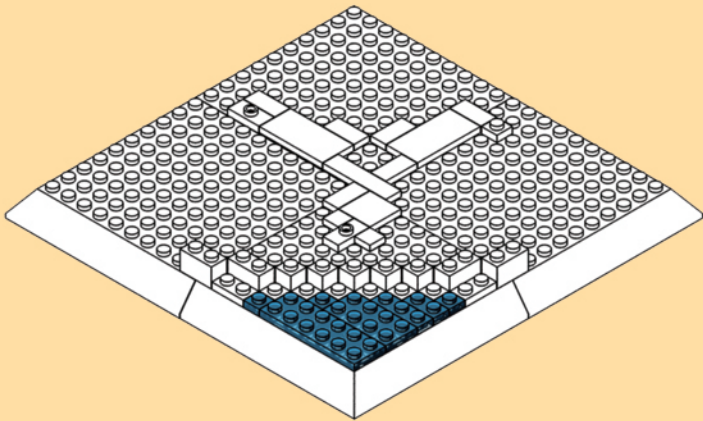

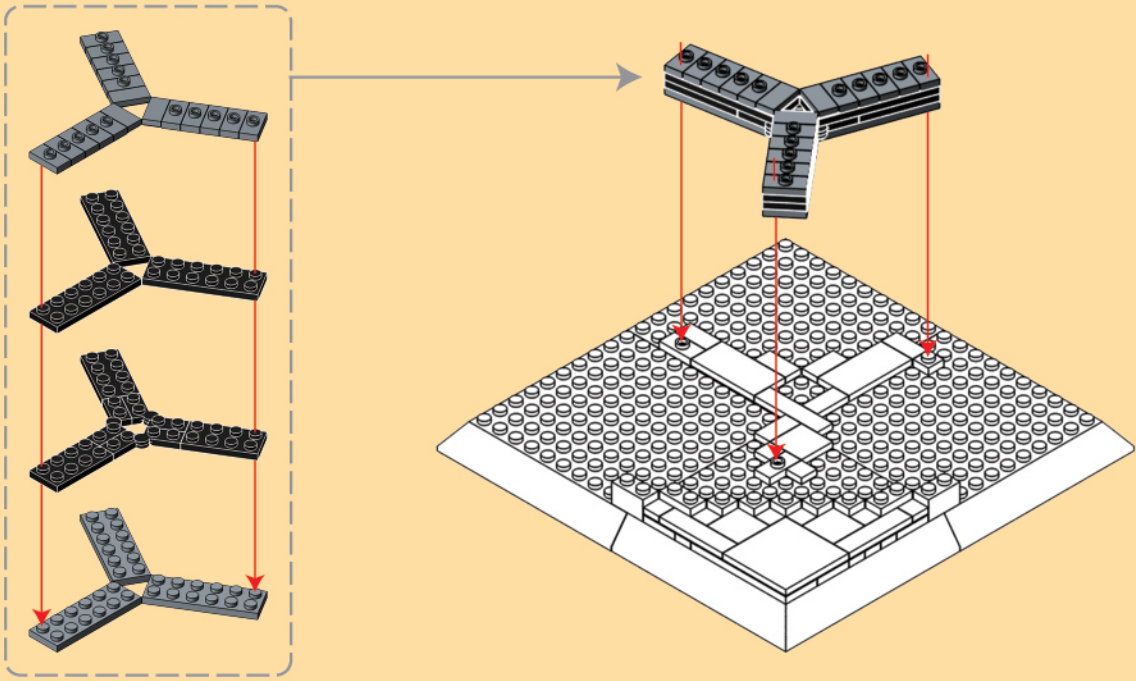
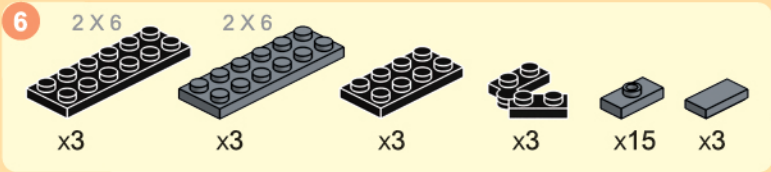
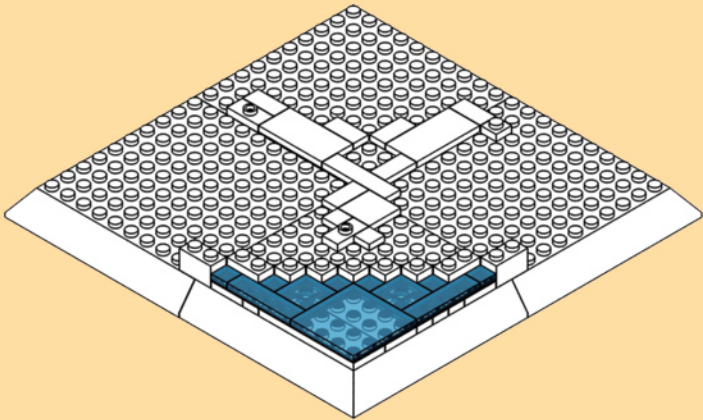
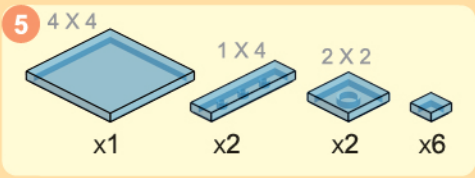

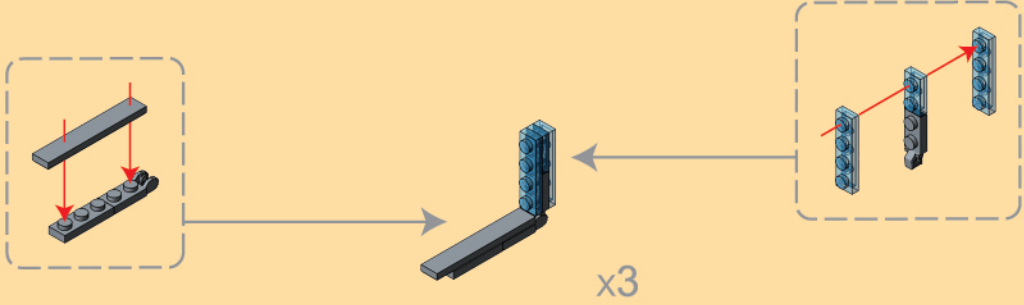
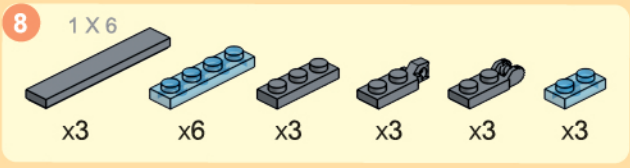
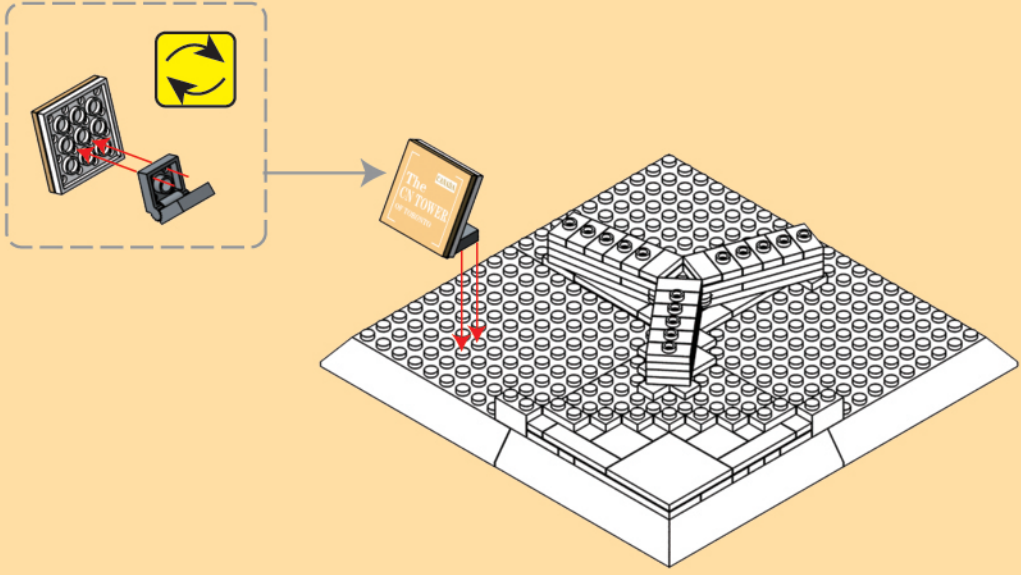
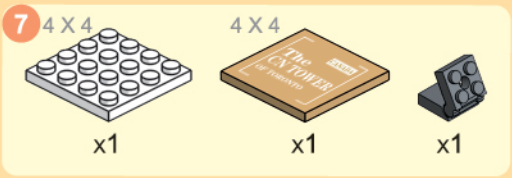

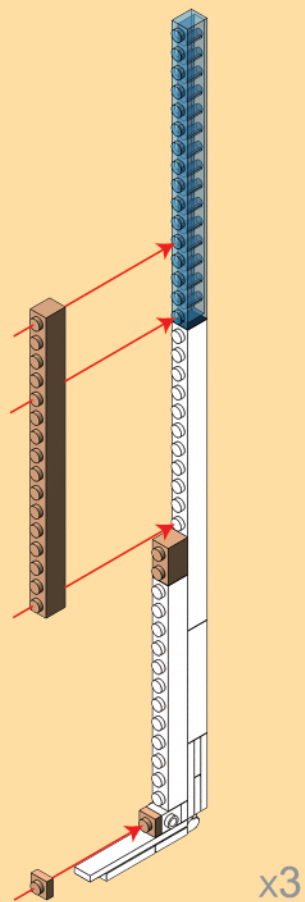
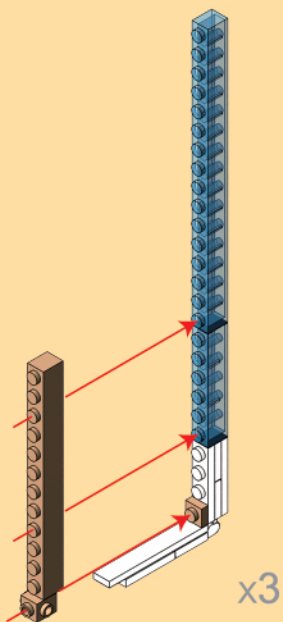
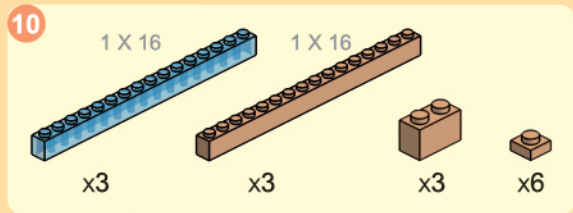
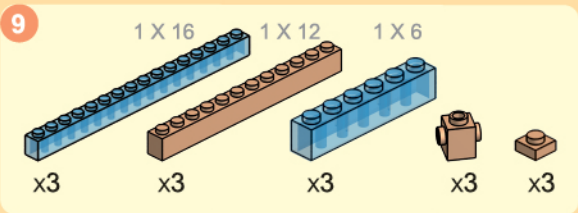

11

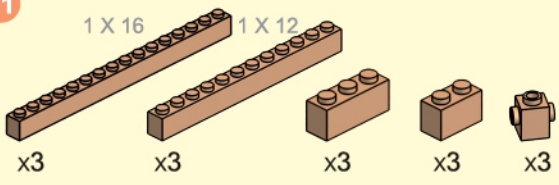

12

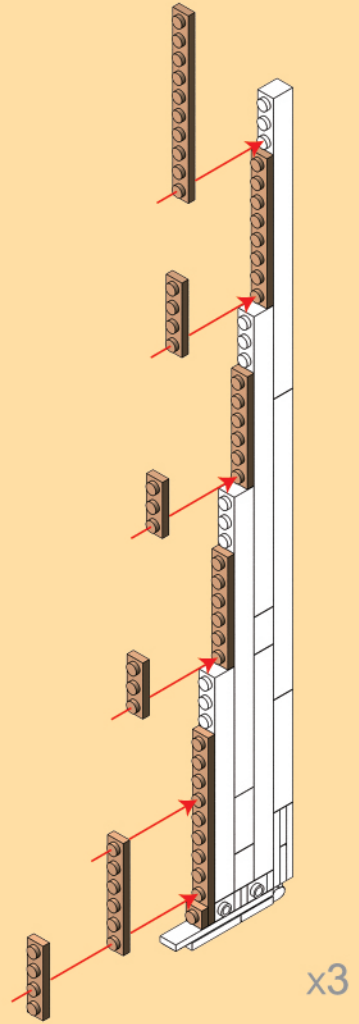
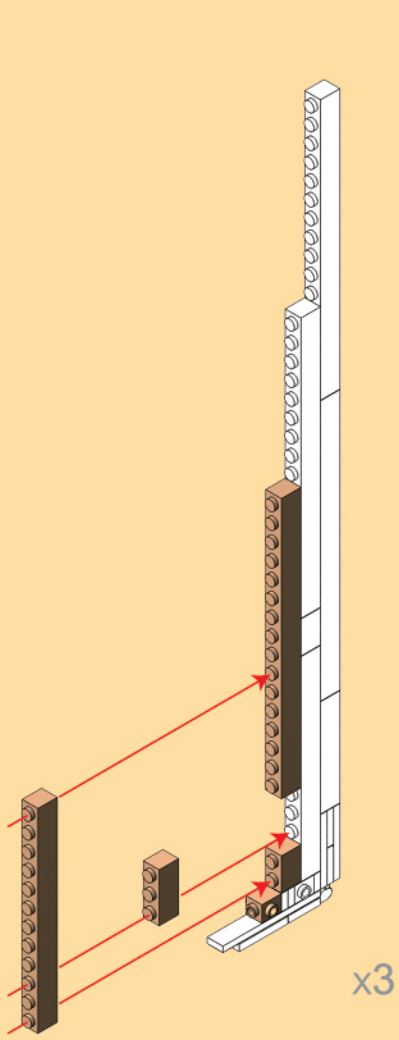
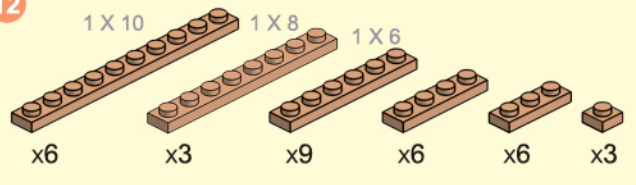

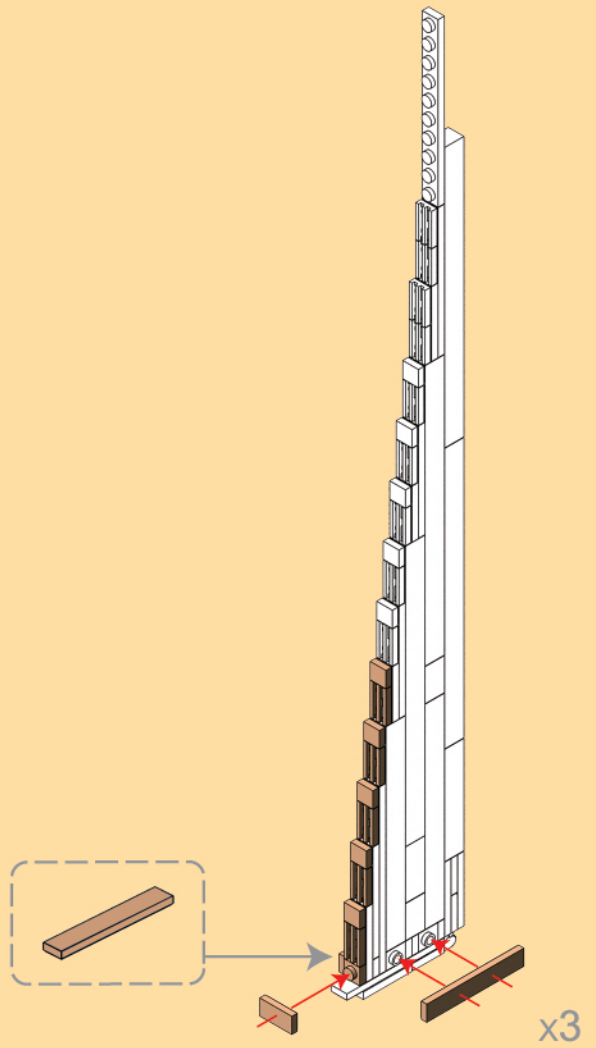
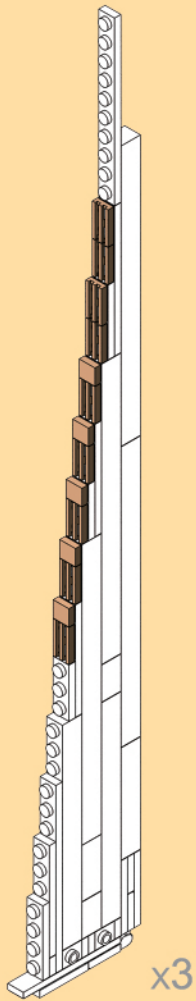
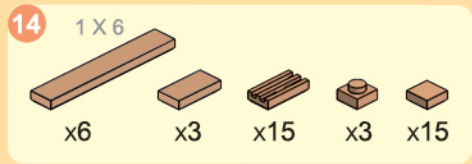

15

7 + 14

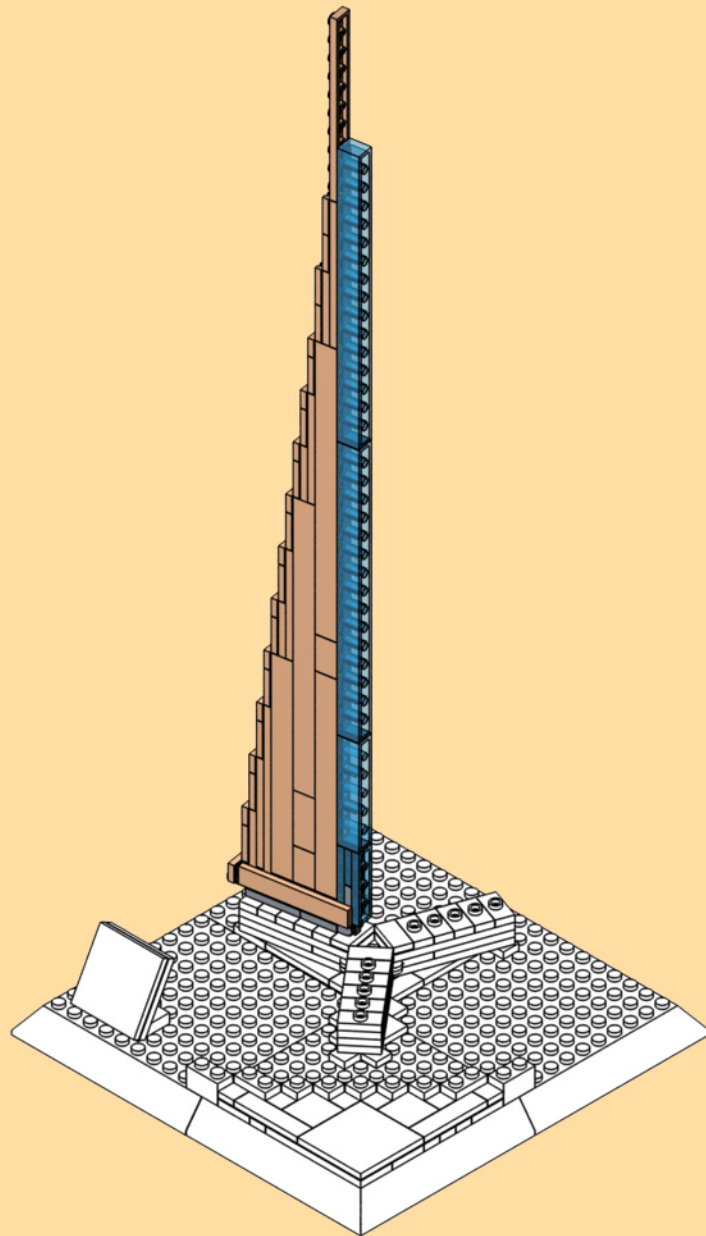

16



x6



x2



x9



x6



x3



x3

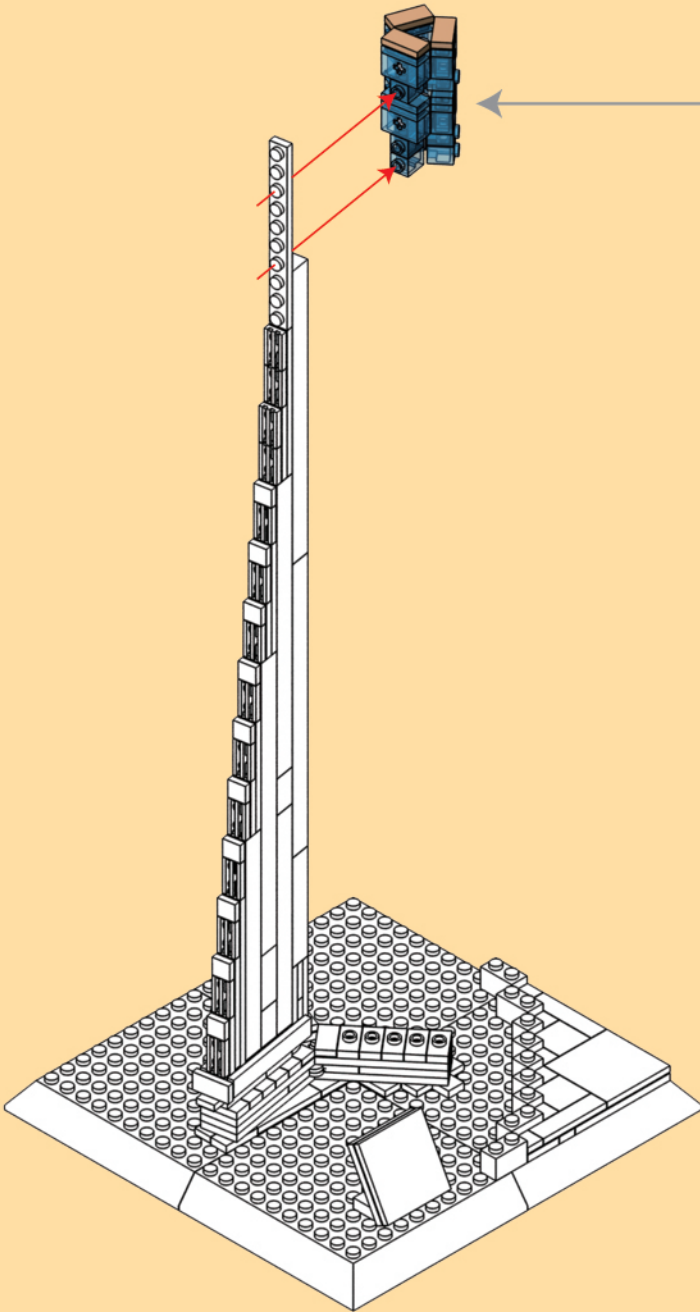

1

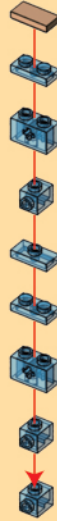

x3

2

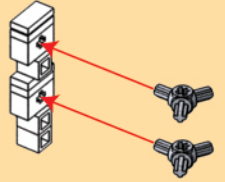

3

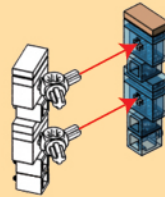

4

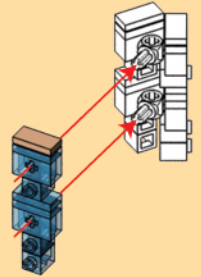

5



17

14 + 16

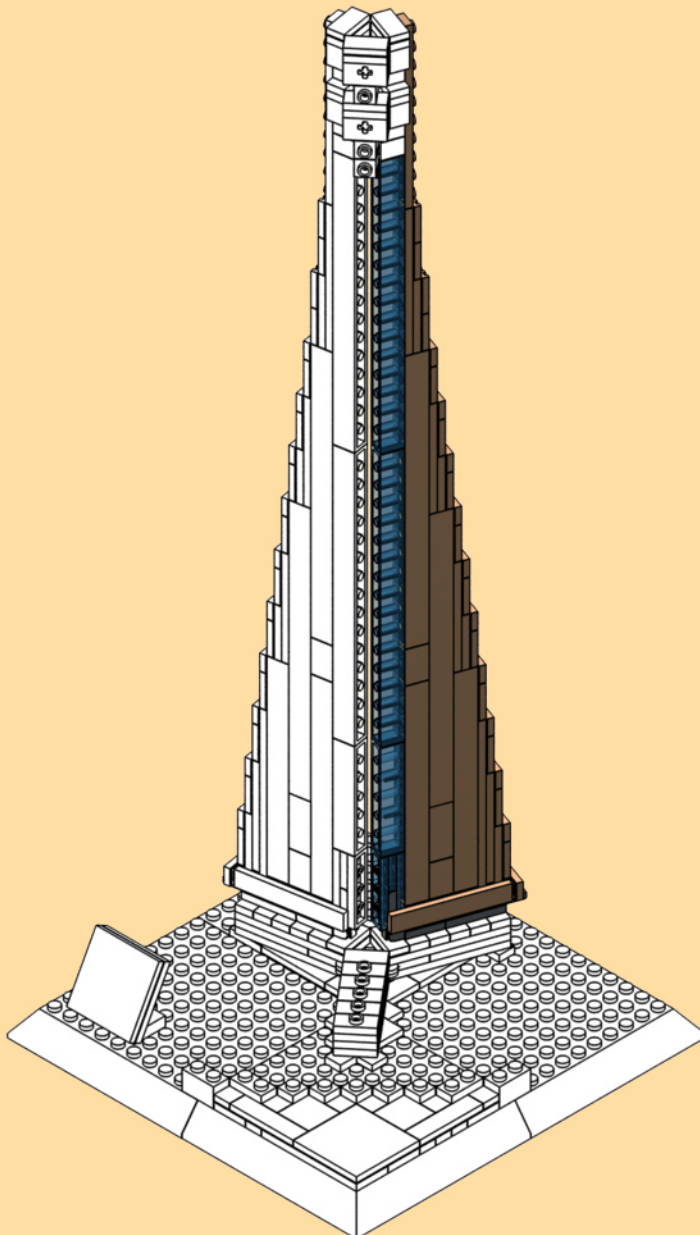

18

14 + 17

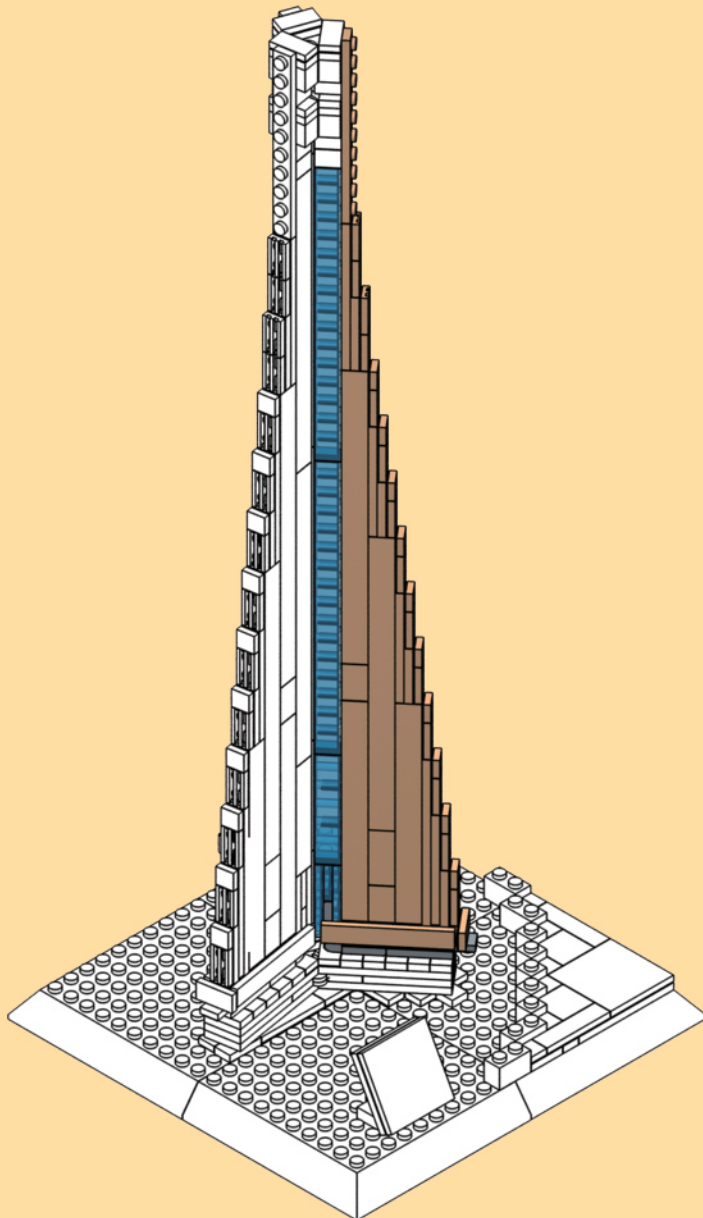

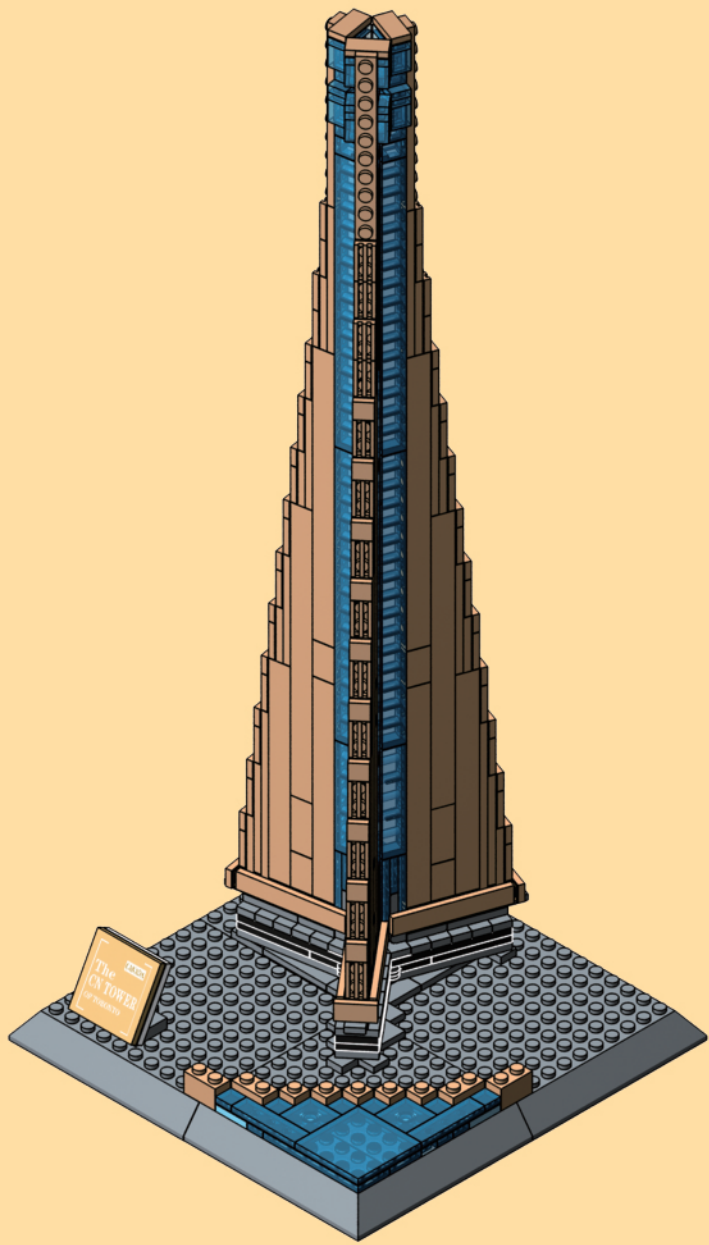

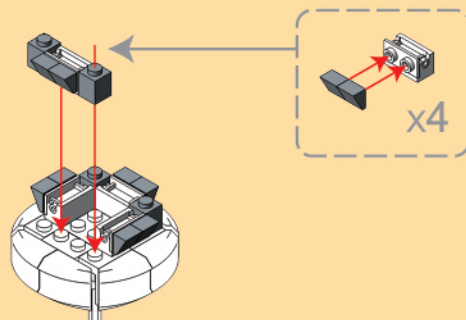
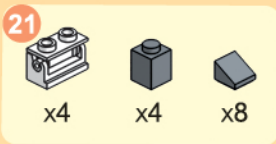
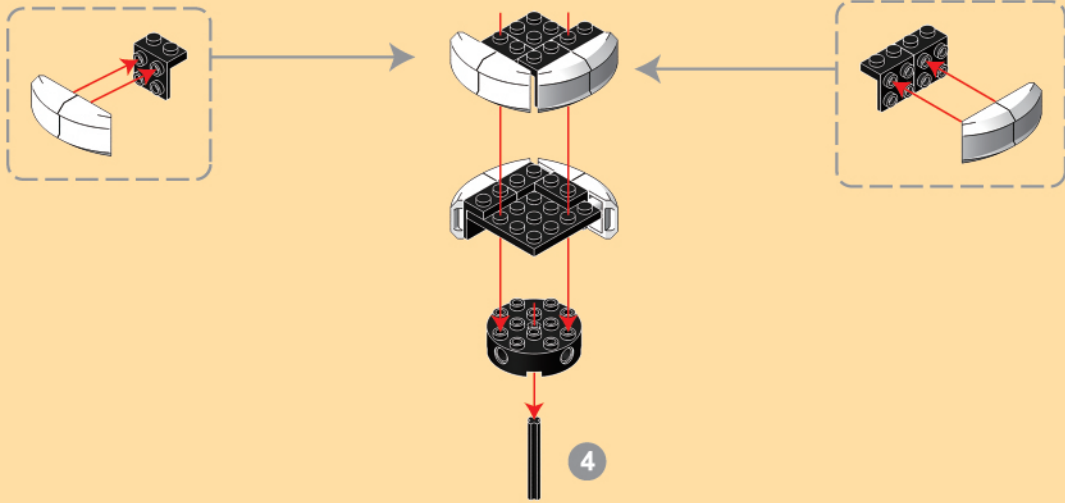
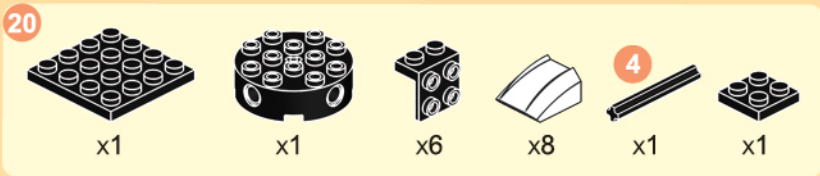

22



x12

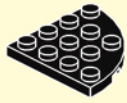

x4

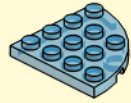

x4

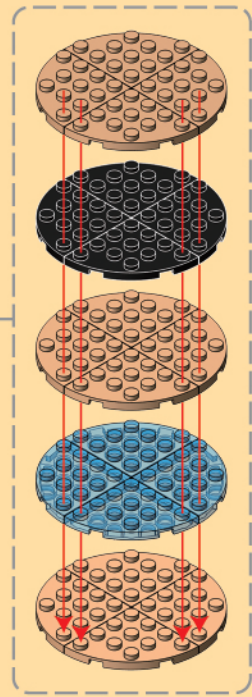
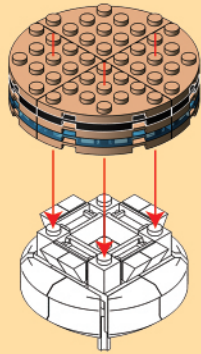

23

2 X 6

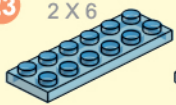

x2



x4



x8



x8

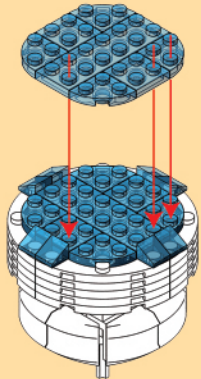

24

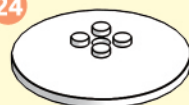

x1

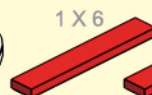

x2

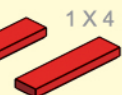

x2



x2



x2

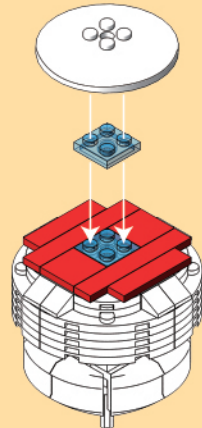

25

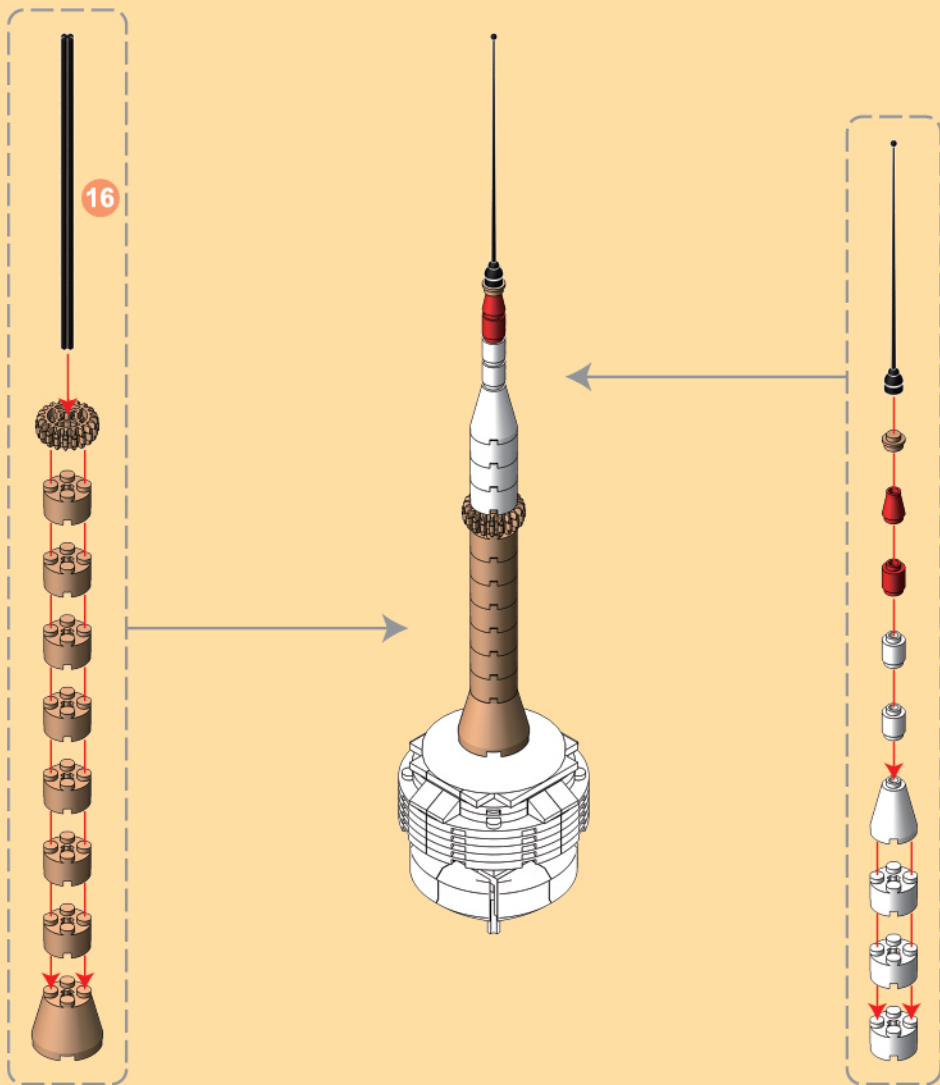

26

19 + 25

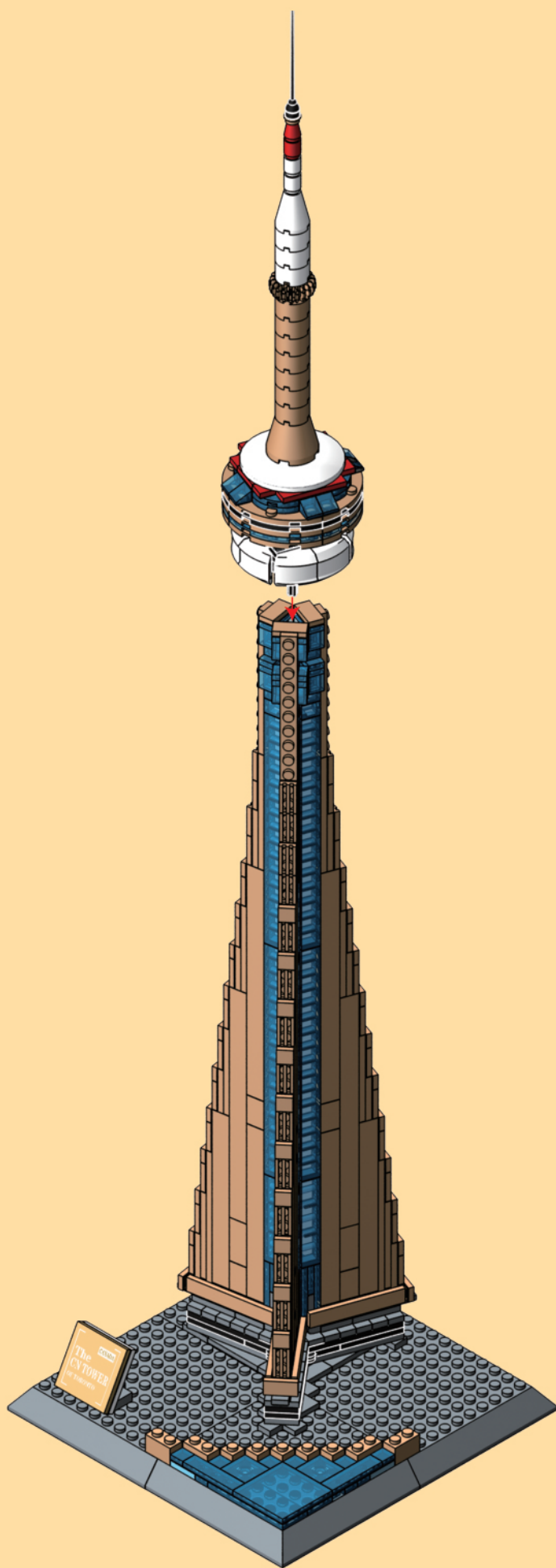

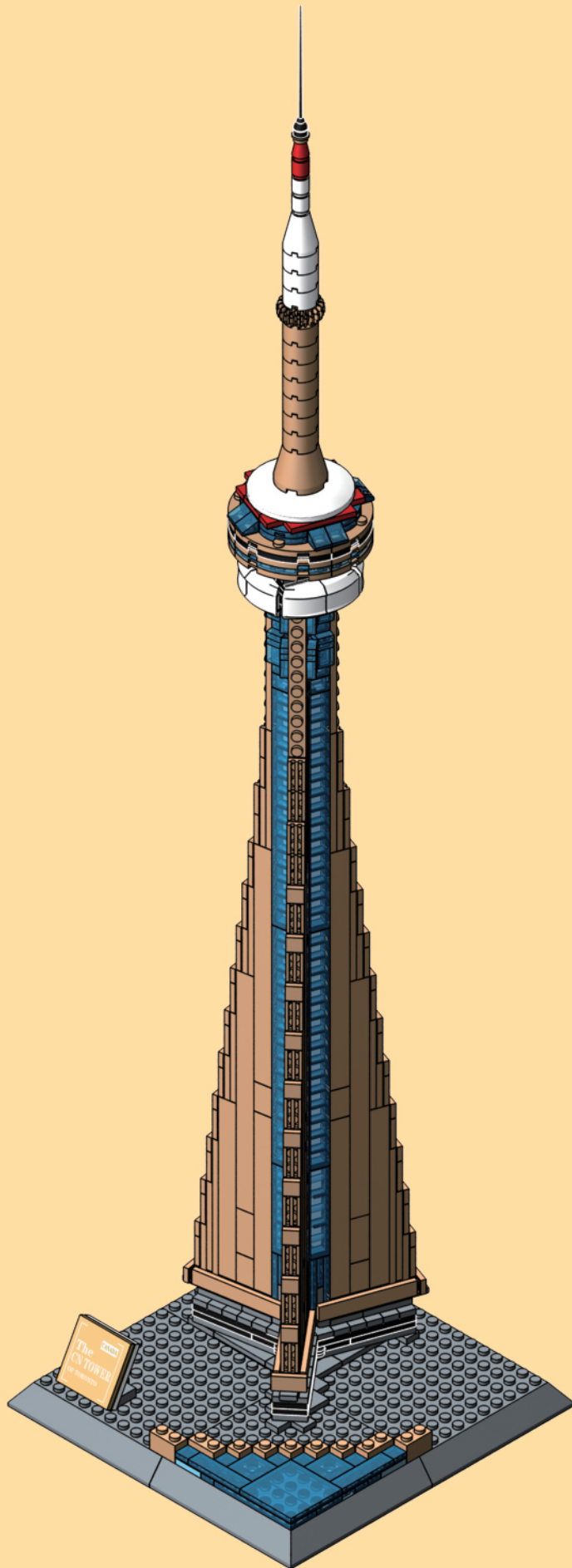

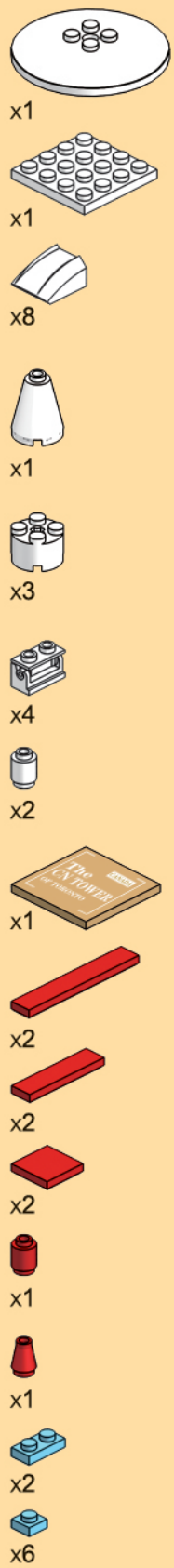
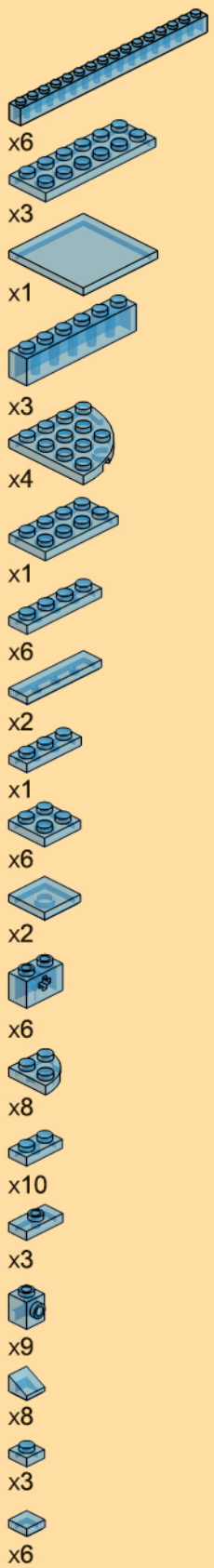
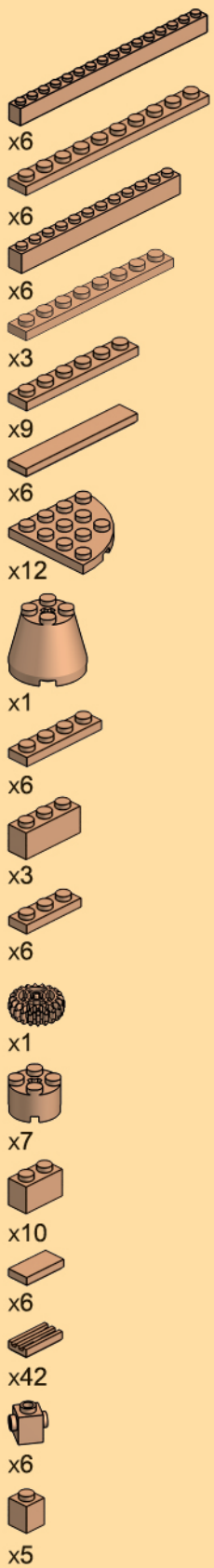
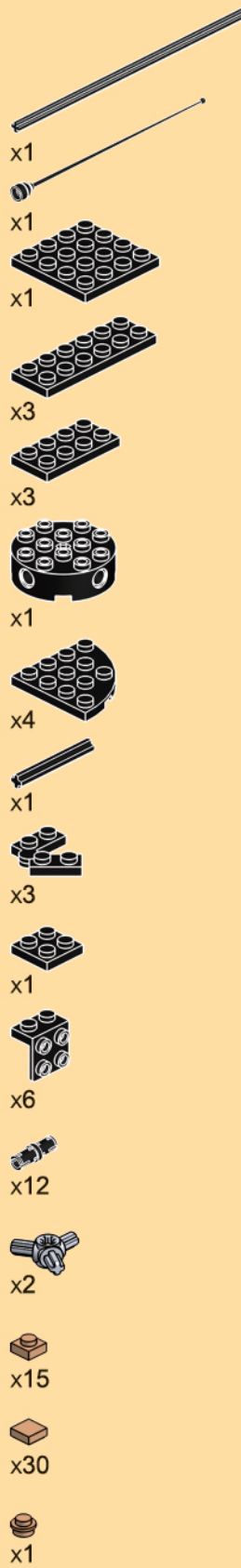
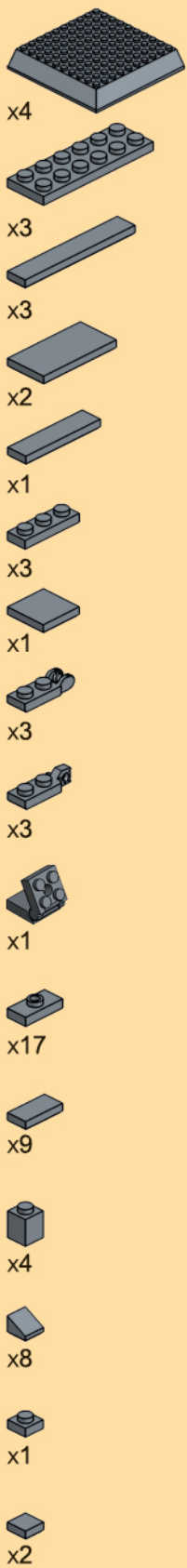



THE CN TOWER OF TORONTO

INTRODUCTION

The CN Tower (in French: Tour CN) is a 533.33 metres-high (1,815.4 ft) concrete communications and observation tower in downtown Toronto, Ontario, Canada. It was completed in 1976, becoming the world's tallest free-standing structure and the world's tallest tower at the time. It held both records for 34 years until the completion of the Burj Khalifa (Dubai) and the Canton Tower (China) in 2010. It is now the 9th tallest tower in the world and remains the tallest free-standing structure in the Western Hemisphere. It is a signature icon of Toronto's skyline, and a symbol of Canada.

Its name "CN" originally referred to Canadian National, the railway company that built the tower. The company sold the tower, but since the name CN Tower became common in daily usage, the abbreviation was eventually expanded from Canadian National Tower to Canada's National Tower. However, neither of these names are commonly used. In 1995, the CN Tower was declared one of the modern Seven Wonders of the World by the American Society of Civil Engineers. It also belongs to the World Federation of Great Towers, where it holds second-place ranking.

LA TOUR CN DE TORONTO

La tour CN (en anglais : CN Tower) est une tour de communications et d'observation en béton de 533,33 mètres. Elle est située au cœur de Toronto, Ontario au Canada. La construction fut complétée en 1976, elle devint alors la plus haute structure autoportante et la plus haute tour du monde. Elle a tenu ce record pendant 34 ans, jusqu'à la construction des tours Burj Khalifa (Dubai) et Canton Tower (Chine) en 2010. Elle est maintenant la 9e plus haute tour au monde, mais elle demeure la plus haute structure autoportante de l'hémisphère occidental. Elle est l'emblème de Toronto et un symbole canadien.

Son nom « CN » faisait initialement référence à son constructeur, la compagnie ferroviaire Canadien National. Lorsqu'elle a été vendue, le nom était ancré dans les mœurs, l'abréviation a donc été changée pour la Tour nationale du Canada (Canada's National Tower). Par contre, ces appellations sont rarement utilisées. En 1995, la Tour CN est déclarée comme une des Sept Merveilles du monde moderne, selon l'American Society of Civil Engineers. Elle appartient aussi à la Fédération des grandes tours du monde où elle détient la seconde place.

ALSO AVAILABLE: AUSSI DISPONIBLES:



PARLIAMENT BUILDINGS
LE PARLEMENT



THE TOWER BRIDGE
TOWER BRIDGE



TAJ MAHAL



THE WHITE HOUSE
LA MAISON-BLANCHE



THE EIFFEL TOWER
LA TOUR EIFFEL



EMPIRE STATE BUILDING



THE BURJ AL ARAB HOTEL
L'HÔTEL BURJ AL ARAB



CATHEDRAL NOTRE-DAME
CATHÉDRALE NOTRE-DAME



THE STATUE OF LIBERTY
LA STATUE DE LA LIBERTÉ



ELIZABETH TOWER
TOUR ELIZABETH



LEANING TOWER OF PISA
LA TOUR DE PISE

Manufactured & Distributed by:
Manufacturé & Distribué par :



IMPORTS DRAGON®
2515, avenue de la Renaissance,
Boisbriand, Qc, Canada, J7H 1T9
514.667.0623

info@importdragon.com
www.importdragon.com
MADE IN CHINA /
FABRIQUÉ EN CHINE

424 PCS
DRAGONBLOK.COM

