



LEANING TOWER OF PISA LA TOUR DE PISE

Italy / Italie

The world's greatest architectural designs /
Les plus grandes œuvres architecturales du monde

6+



- | | | | | |
|------------|-----------------------|-------------|--------------|-------------------|
| Creativity | Family Interaction | Observation | Reasoning | Fine motor skills |
| | | | | |
| Créativité | Interaction familiale | Observation | Raisonnement | Motricité fine |

1334 PCS

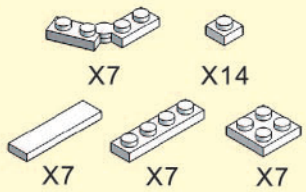

1

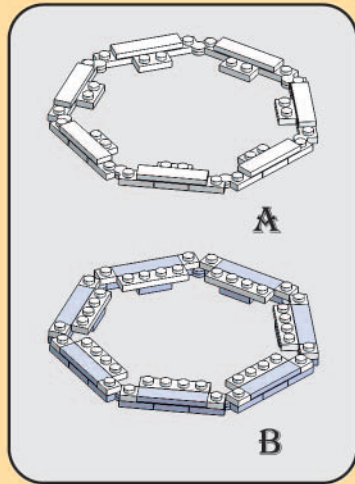
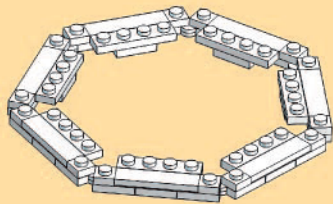

A

B

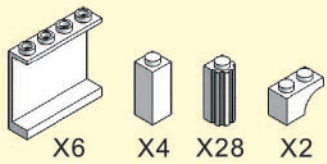

2

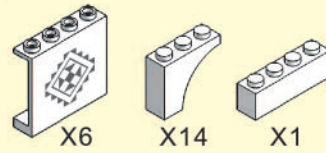
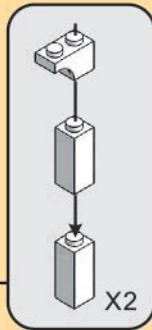
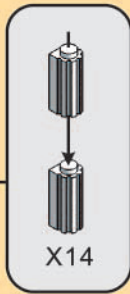
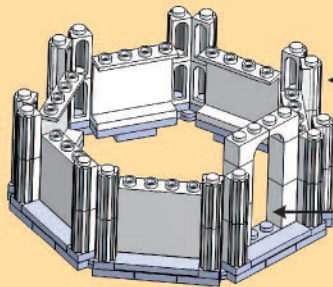

3

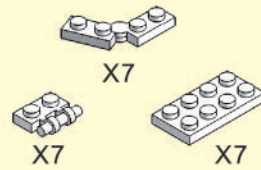
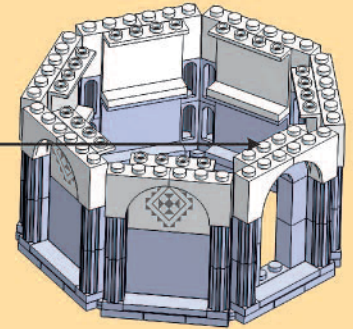
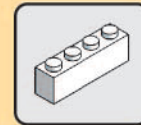

4

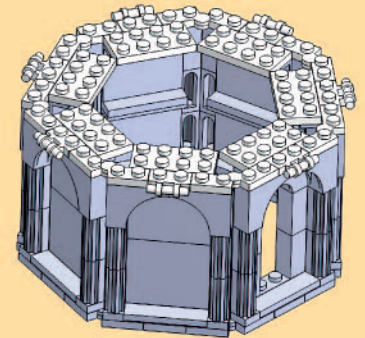

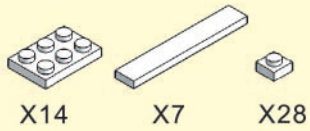

5

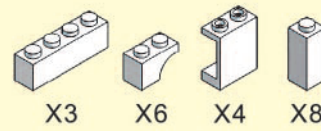
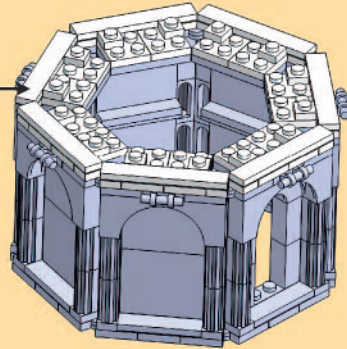
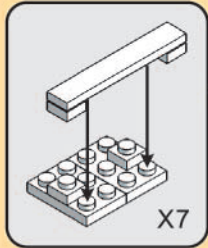

7

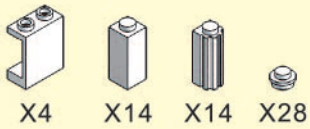
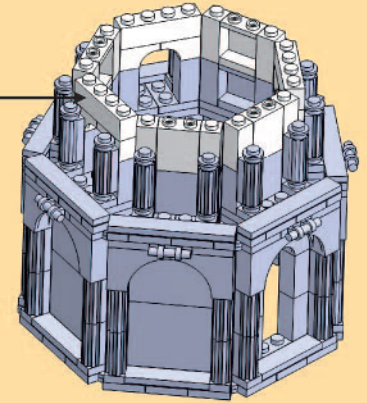
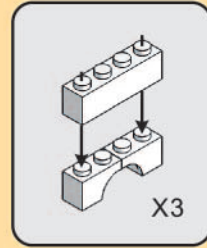

6

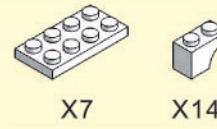
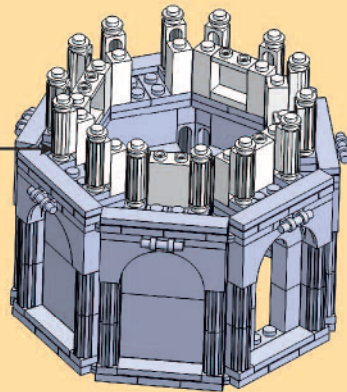
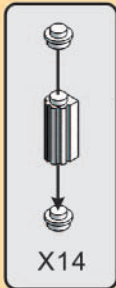

8

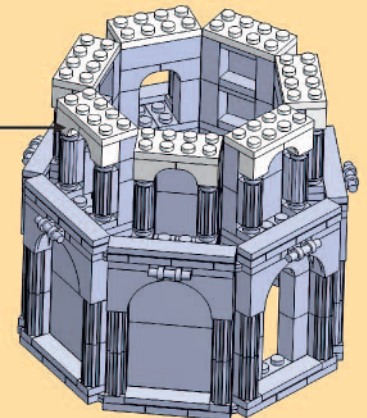
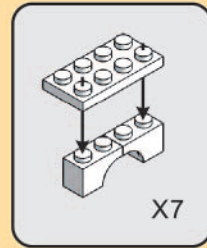

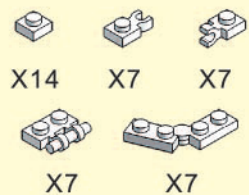

9

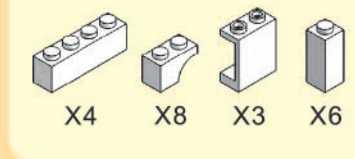
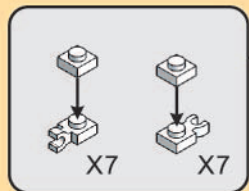
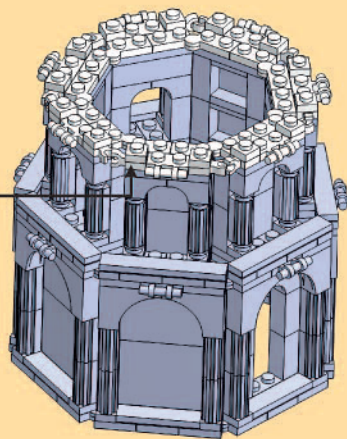

11

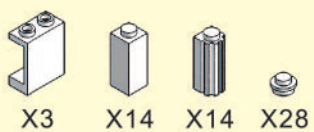
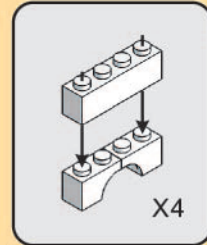
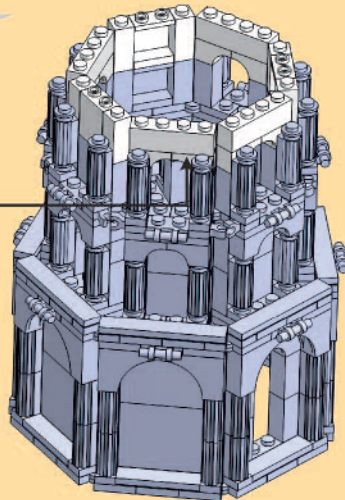

10

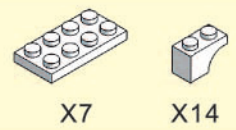
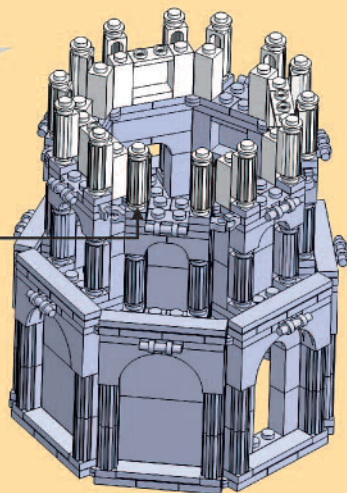

12

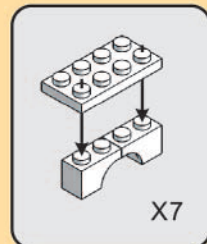
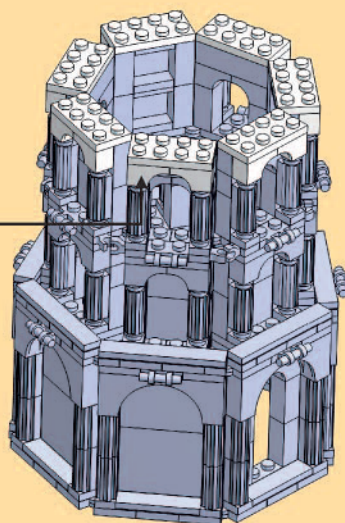

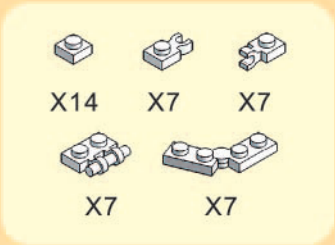

13

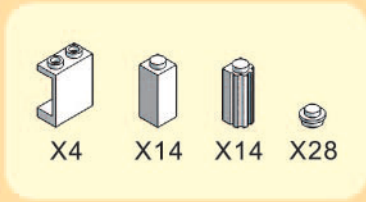

14

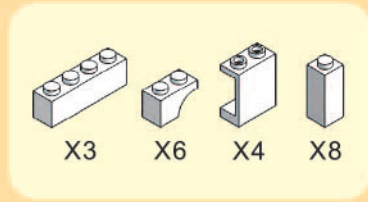

15

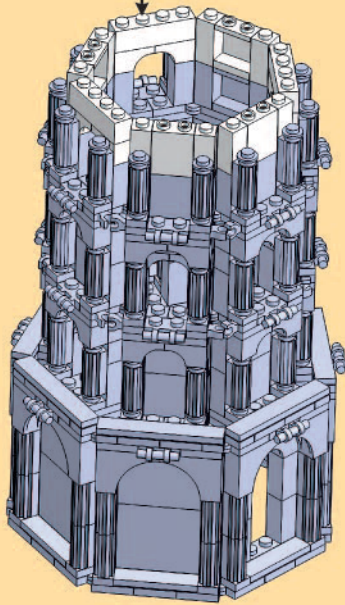
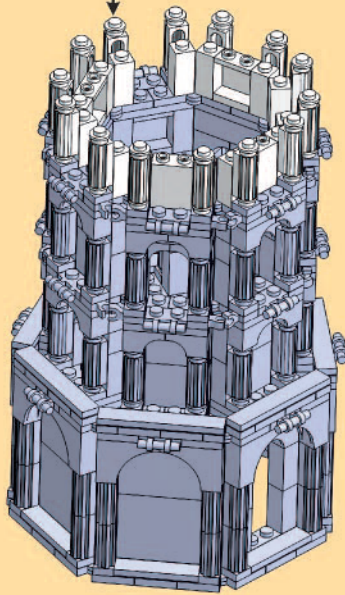
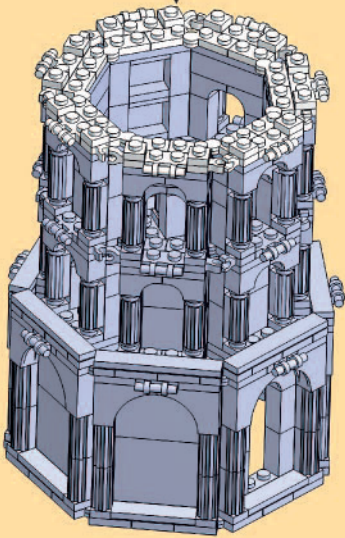
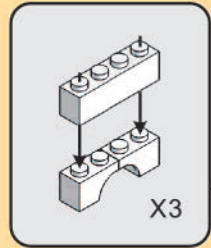
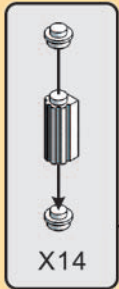
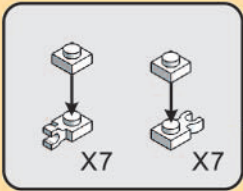

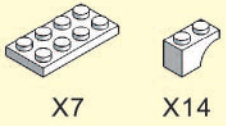

16

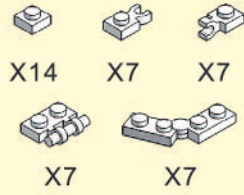

17

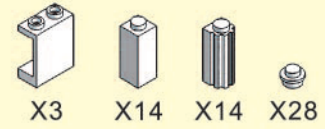

18

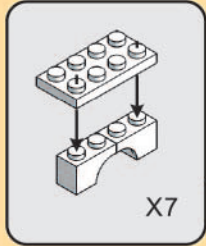

X7

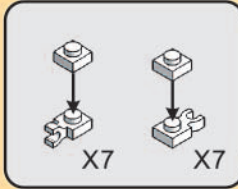

X7

X7

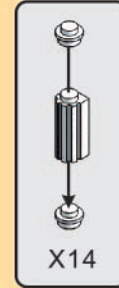

X14

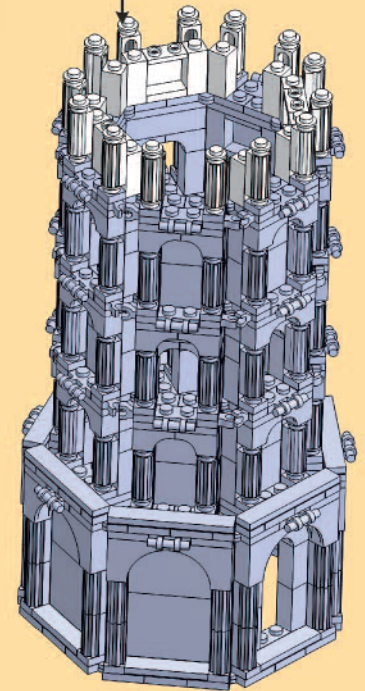
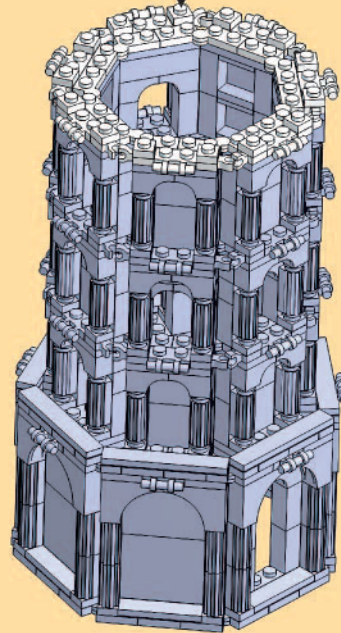
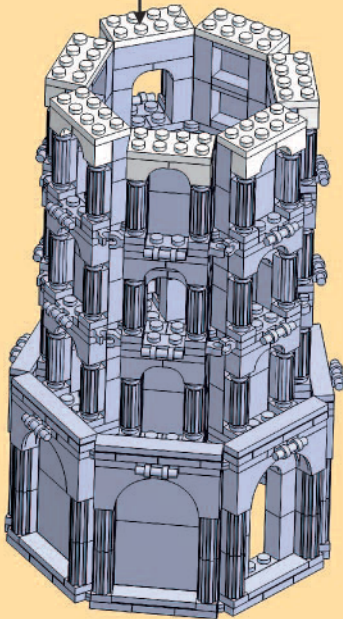

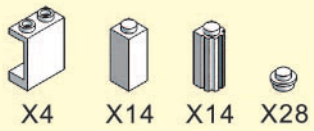

22

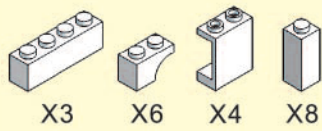

23

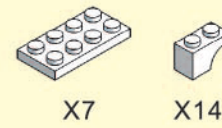

24

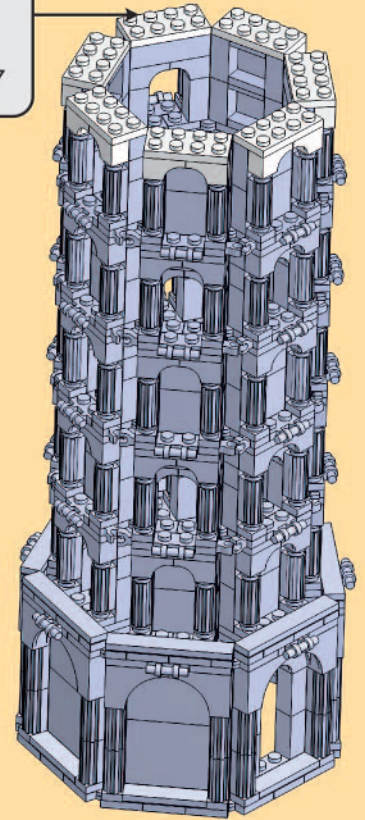
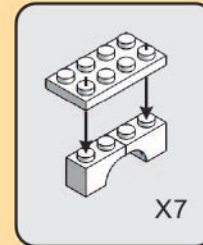
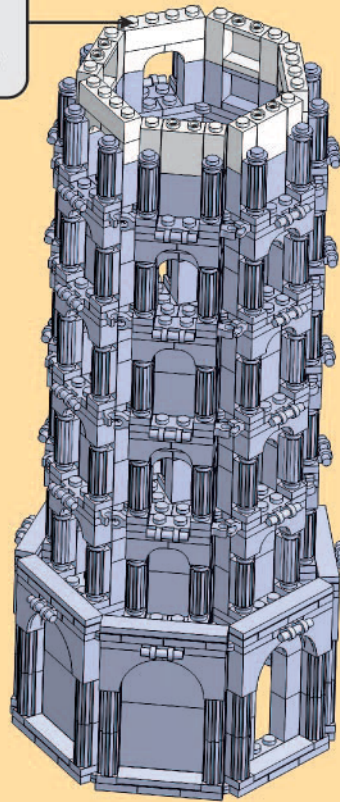
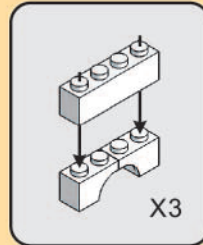
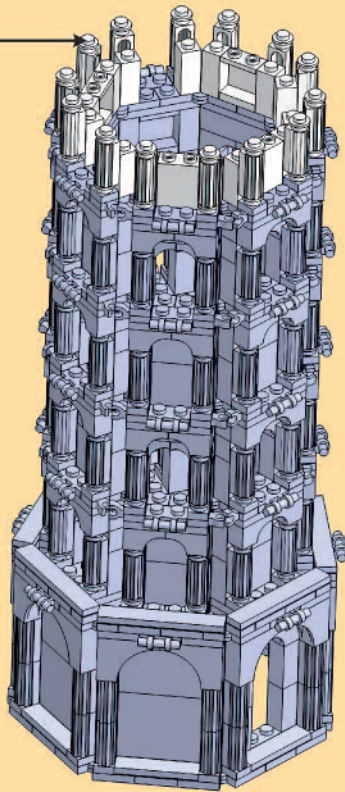
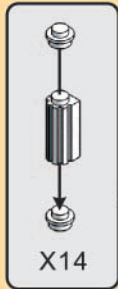

X14 X7 X7

 X7 X7

25

X3 X14 X14 X28

26

X4 X8 X3 X6

27

X7 X7

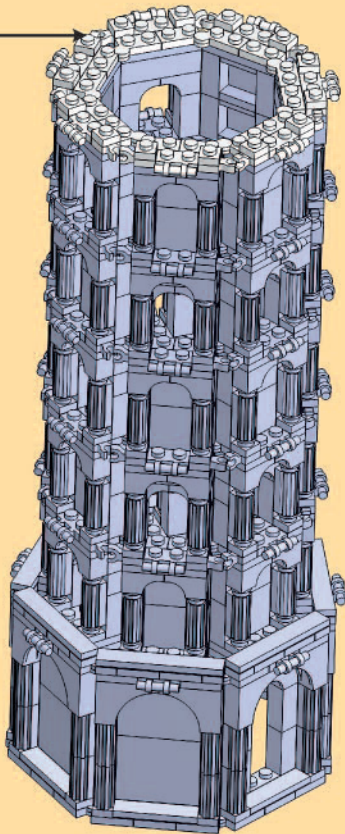

X14

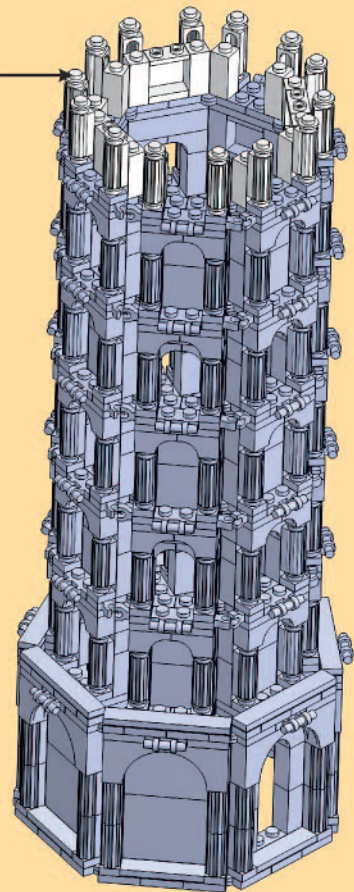

X4

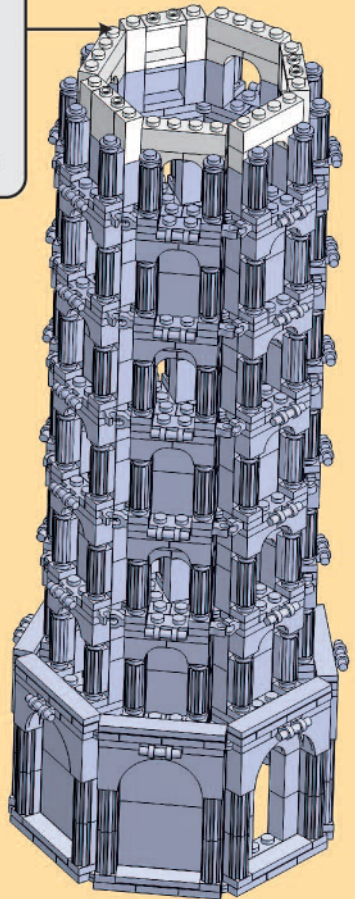

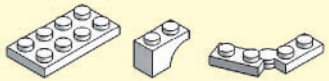

X7 X14 X7

28



X7 X7



X7 X7

29

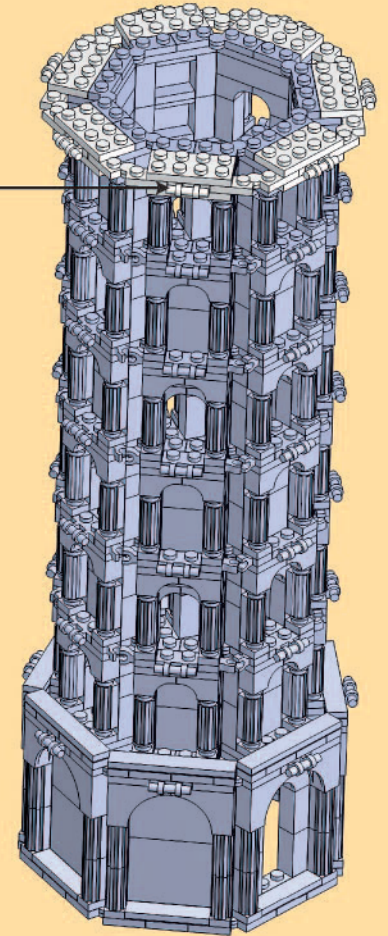
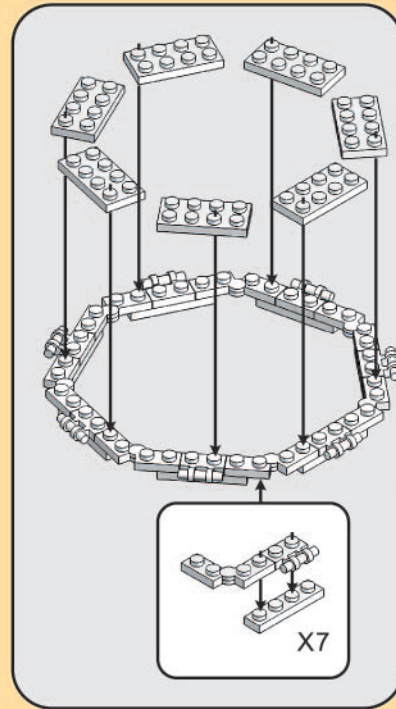
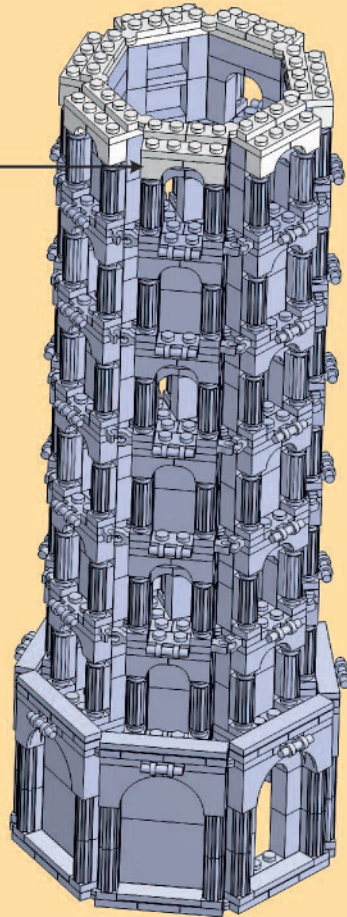
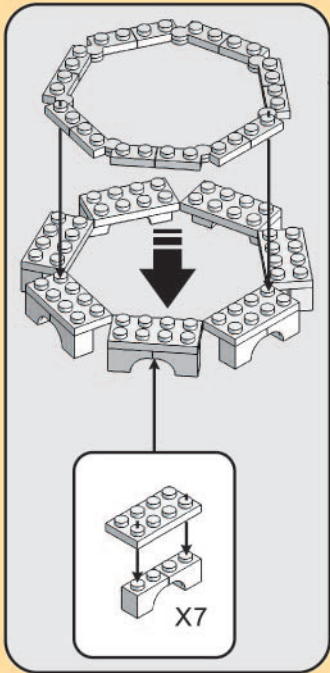



X7



X14



X14

30

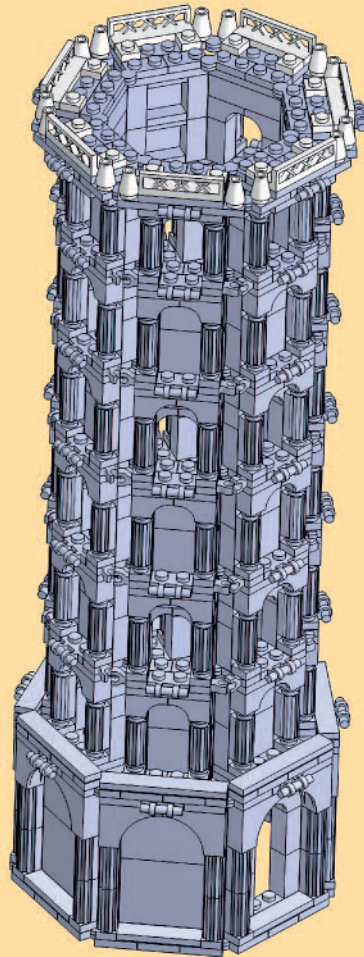

X28



X14



X14



X14

31

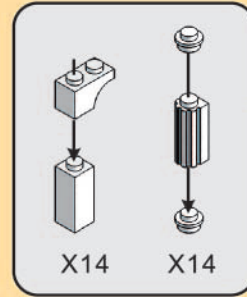

X14

X14

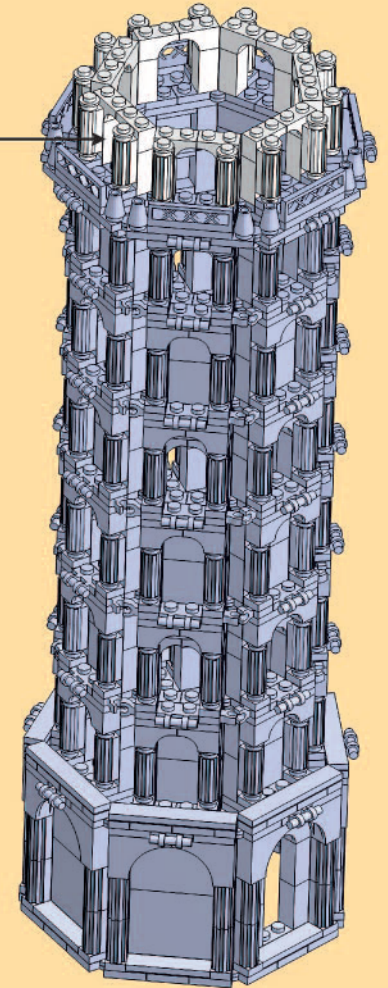



X14



X14

32

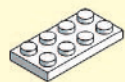

X7



X7



X14

33

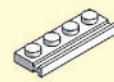

X7



X7



X7

34

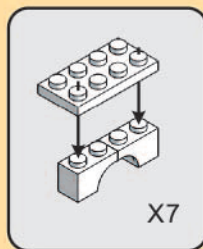
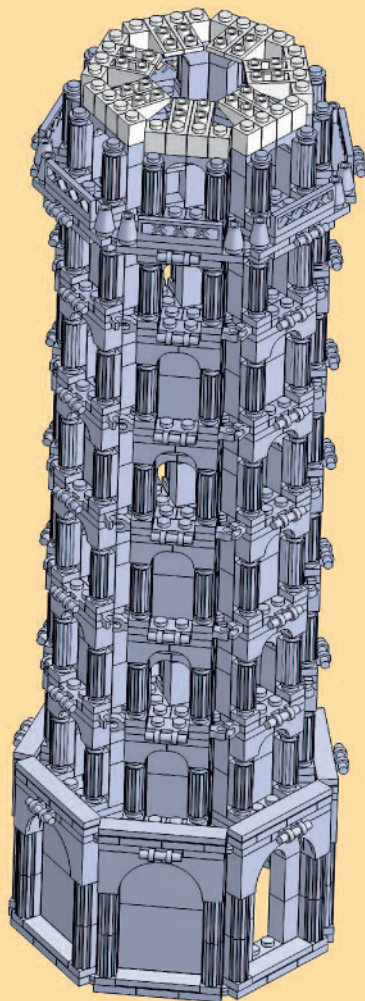

X7

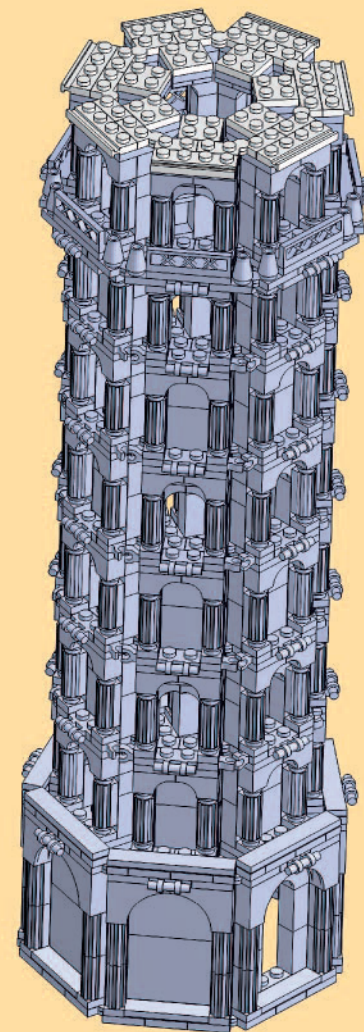
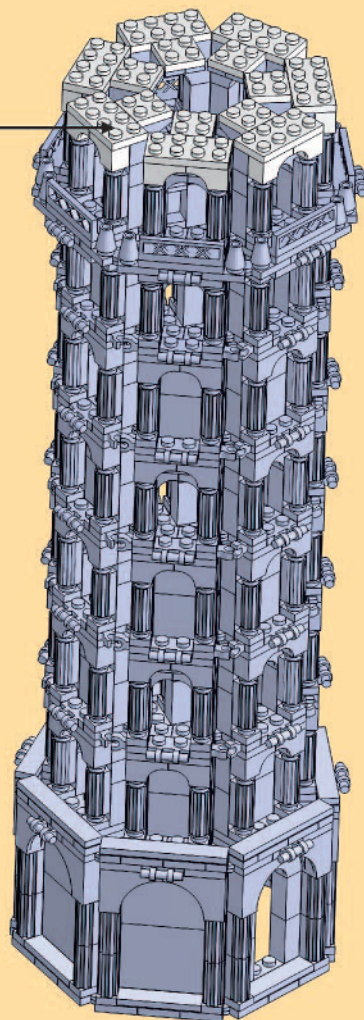

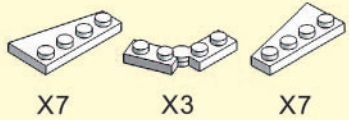

35

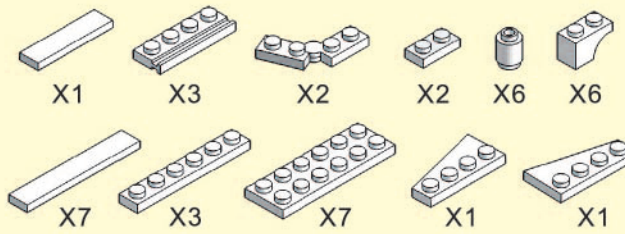

36

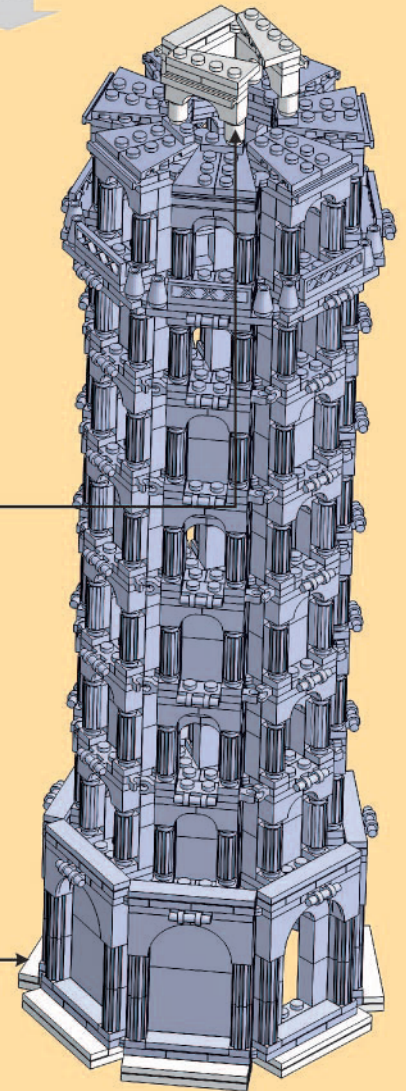
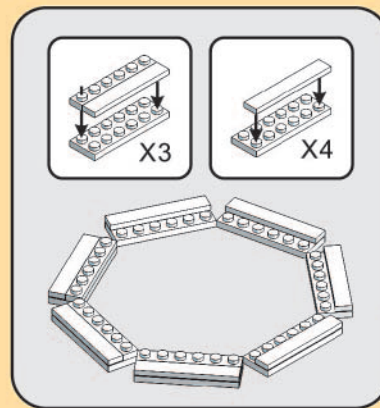
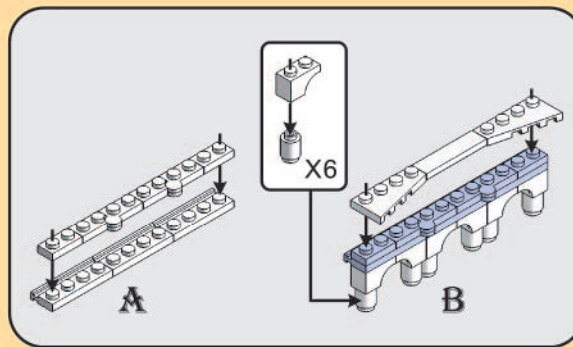
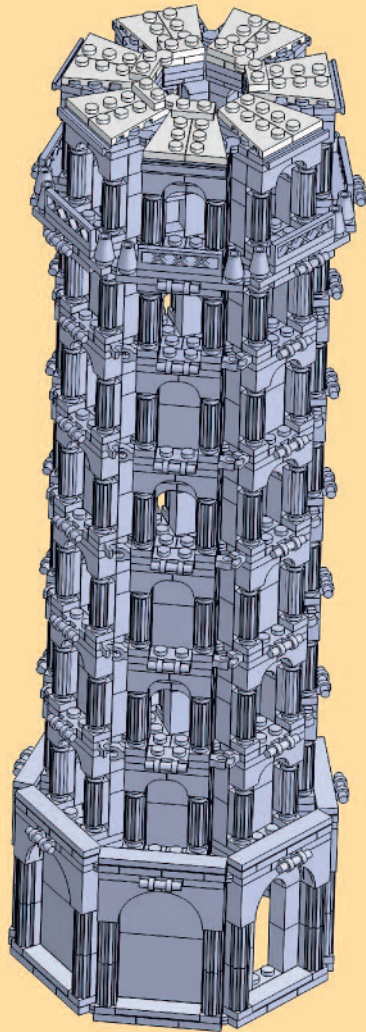

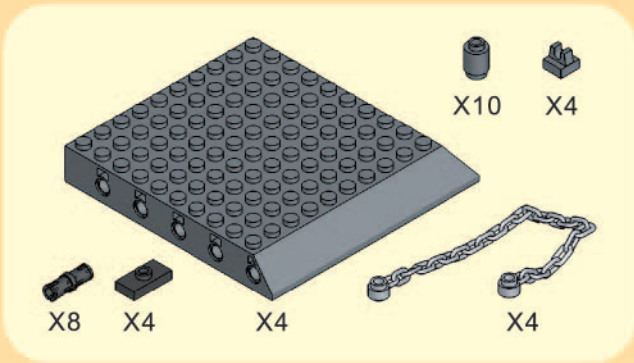

37

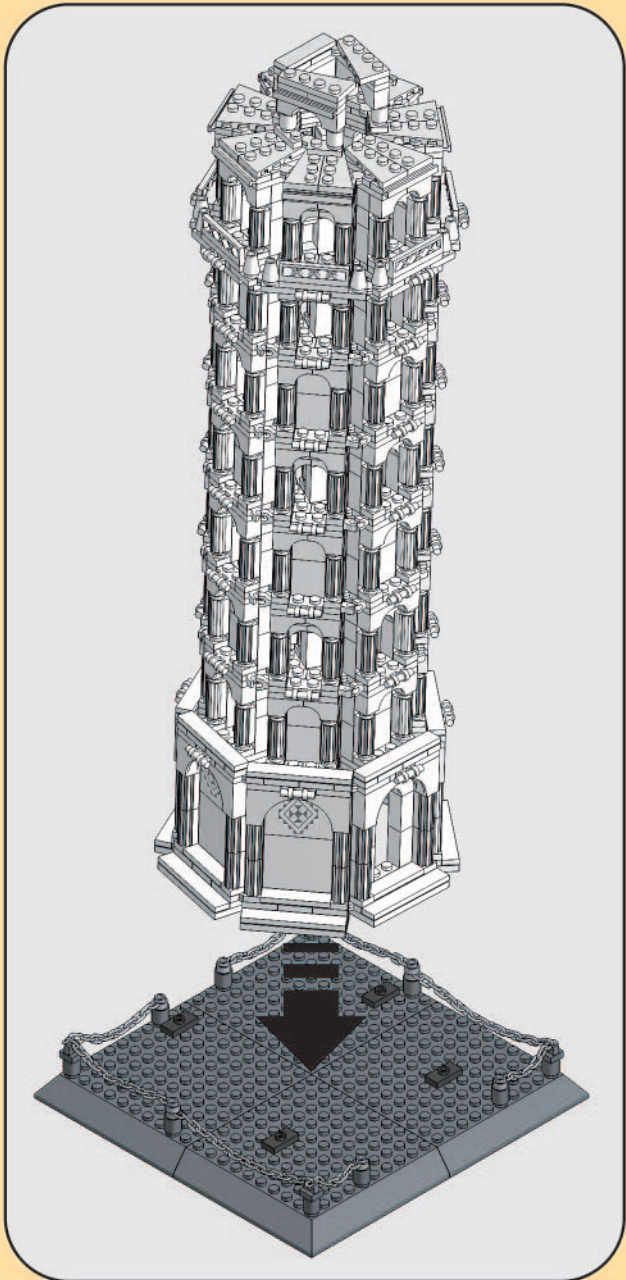
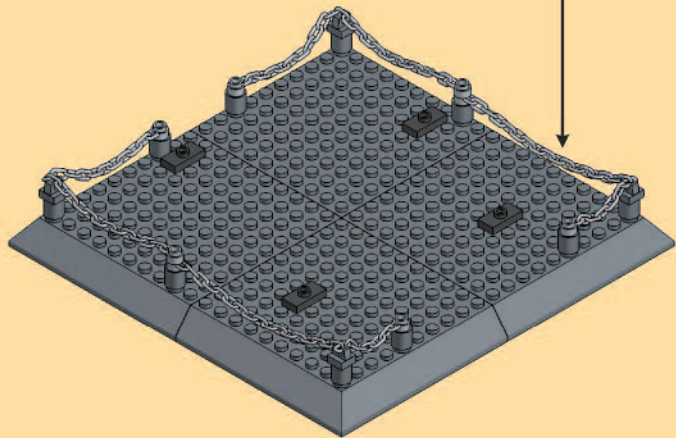
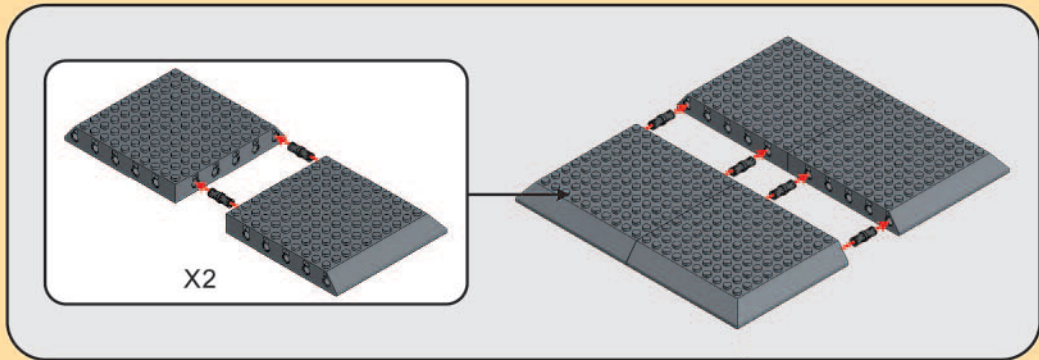

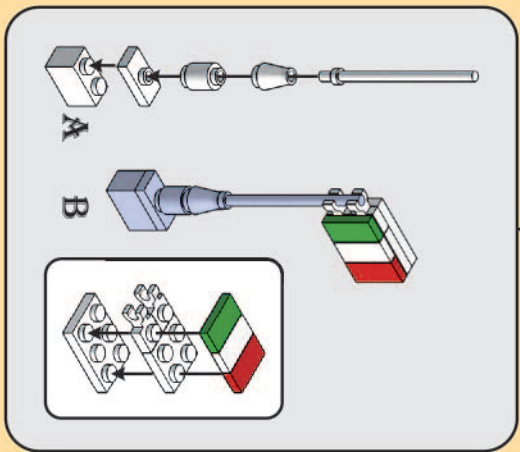
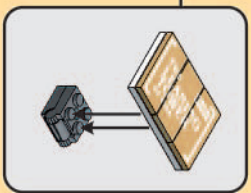
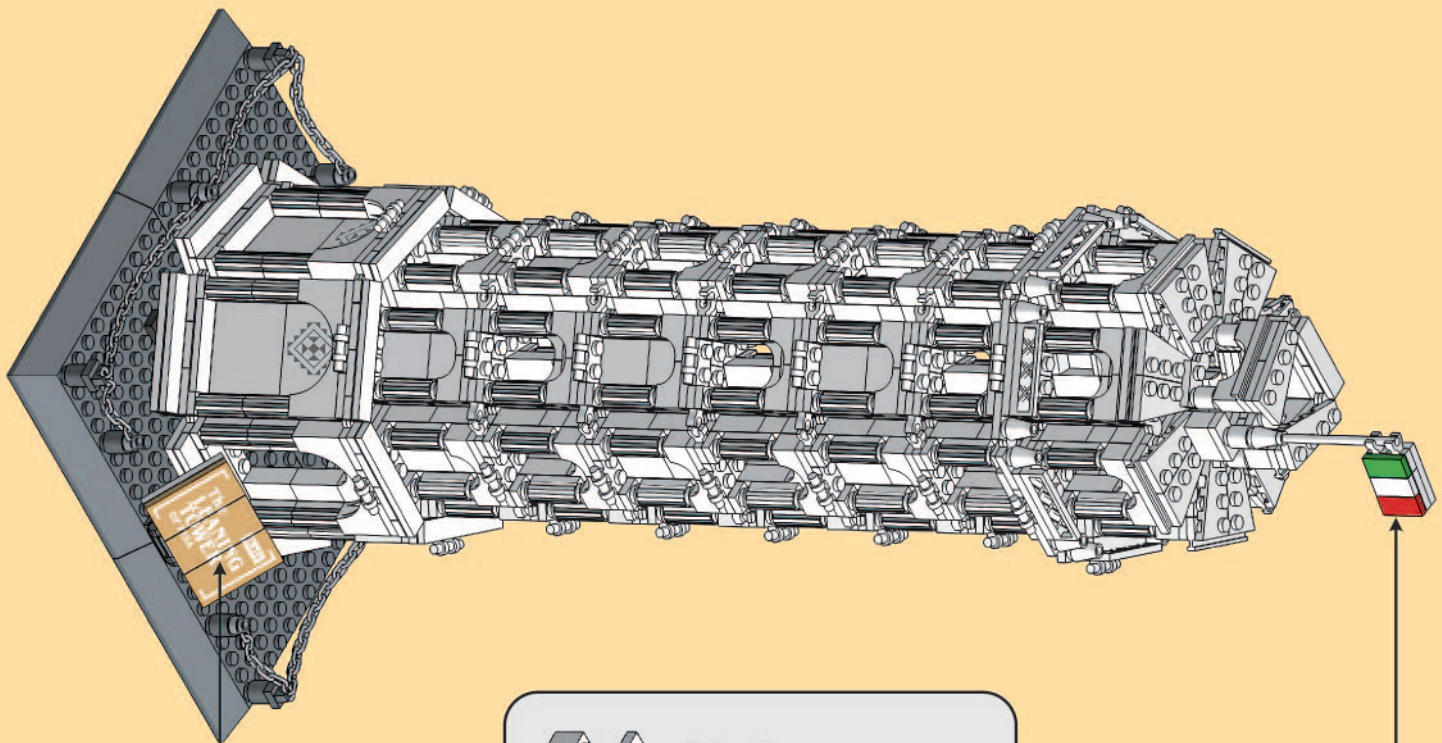

- | | | | |
|----|--|----|--|
| X1 | | X1 | |
| X1 | | X1 | |
| X1 | | X2 | |
| X1 | | X1 | |
| X1 | | X1 | |
| X1 | | X1 | |

38



LEANING TOWER OF PISA

INTRODUCTION

The Leaning Tower of Pisa or simply the Tower of Pisa is known worldwide for its unintended tilt. It is the bell tower of the cathedral in the Italian city of Pisa. The tower is situated behind the Pisa Cathedral and is the third-oldest structure in the city's Cathedral Square, after the Cathedral and the Baptistry. It took more than 199 years to build the tower. The first stage of the construction started in 1173, the first three floors were built, construction stopped in 1178 because Pisa was at war. In 1272, construction resumed and the next three floors were built, but work was halted again in 1284. The final floors were added between 1319 and 1350. The tower was designed to be vertical. However, only five years after work on the tower began, it was noticeably leaning. The tilt was first noticed during construction of the third floor. The tower's tilt is caused because of an inadequate foundation on ground too soft on one side, and it can't properly support the structure's weight. In 1990 the tower leaned at an angle of 5.5°, but after restoration work between 1993 and 2001 it was reduced to 3.97°. The height of the tower is 55.86 metres (183.27 feet) from the ground on the low side and 56.67 metres (185.93 feet) on the high side.

LA TOUR DE PISE

La tour de Pise est mondialement connue à cause de son inclinaison caractéristique. Il s'agit du campanile de la cathédrale de Pise. La tour est située à proximité de la cathédrale et elle est la troisième plus ancienne structure de la ville après la Cathédrale et le Baptistère de Pise. Il a fallu plus de 199 ans pour terminer la construction de la tour. La première phase de la construction commence en 1173, trois étages sont construits, mais la construction est interrompue par une guerre. En 1272, la construction reprend et les trois étages suivants sont construits, mais la construction est de nouveau interrompue en 1284. Les derniers étages sont ajoutés entre 1319 et 1350. La tour devait être verticale. Par contre, seulement cinq ans après le début de la construction, on remarque l'inclinaison lors de la construction du troisième étage. Implantée sur un site particulièrement ingrat, la tour subit un affaissement en raison de tassements et de fondations inadéquates qui ne peuvent pas supporter le poids de la structure. En 1990, l'inclinaison était de 5,5°, mais après les travaux de restauration entre 1993 et 2001, l'inclinaison était de 3,97°. La tour mesure 55,86 mètres (183,27 pieds) du côté sud et 56,71 mètres (185,93 pieds) du côté nord, à cause de son inclinaison.

ALSO AVAILABLE: AUSSI DISPONIBLES:

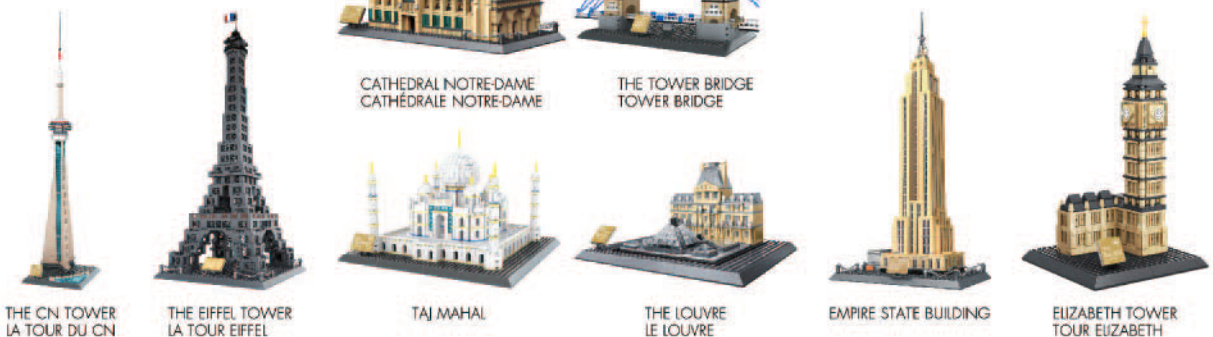

THE CN TOWER
LA TOUR DU CN

THE EIFFEL TOWER
LA TOUR EIFFEL

CATHEDRAL NOTRE-DAME
CATHÉDRALE NOTRE-DAME

THE TOWER BRIDGE
TOWER BRIDGE

TAJ MAHAL

THE LOUVRE
LE LOUVRE

EMPIRE STATE BUILDING

ELIZABETH TOWER
TOUR ELIZABETH

Imports
DragonBlok
Distributed By/Distribué par :
IMPORTS DRAGON®
2515, av. de la Renaissance,
Boisbriand, Québec,
Canada, J7H 1T9
www.importdragon.com

Manufactured by
DragonBlok
Shantou VinyFun Toys & Nursery Co., Ltd.
© 2017 Wange
All Rights Reserved. Tous droits réservés.
www.wange toys.com
MADE IN CHINA /
FABRIQUÉ EN CHINE

1334 PCS
DRAGONBLOK.COM

