

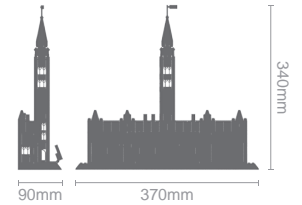

# PARLIAMENT BUILDINGS LE PARLEMENT

Canada  
The world's greatest architectural designs /  
Les plus grandes œuvres architecturales du monde

## 10+



- |            |                       |             |              |                   |
|------------|-----------------------|-------------|--------------|-------------------|
| Creativity | Family Interaction    | Observation | Reasoning    | Fine motor skills |
|            |                       |             |              |                   |
| Créativité | Interaction familiale | Observation | Raisonnement | Motricité fine    |

**608 PCS**







279PCS

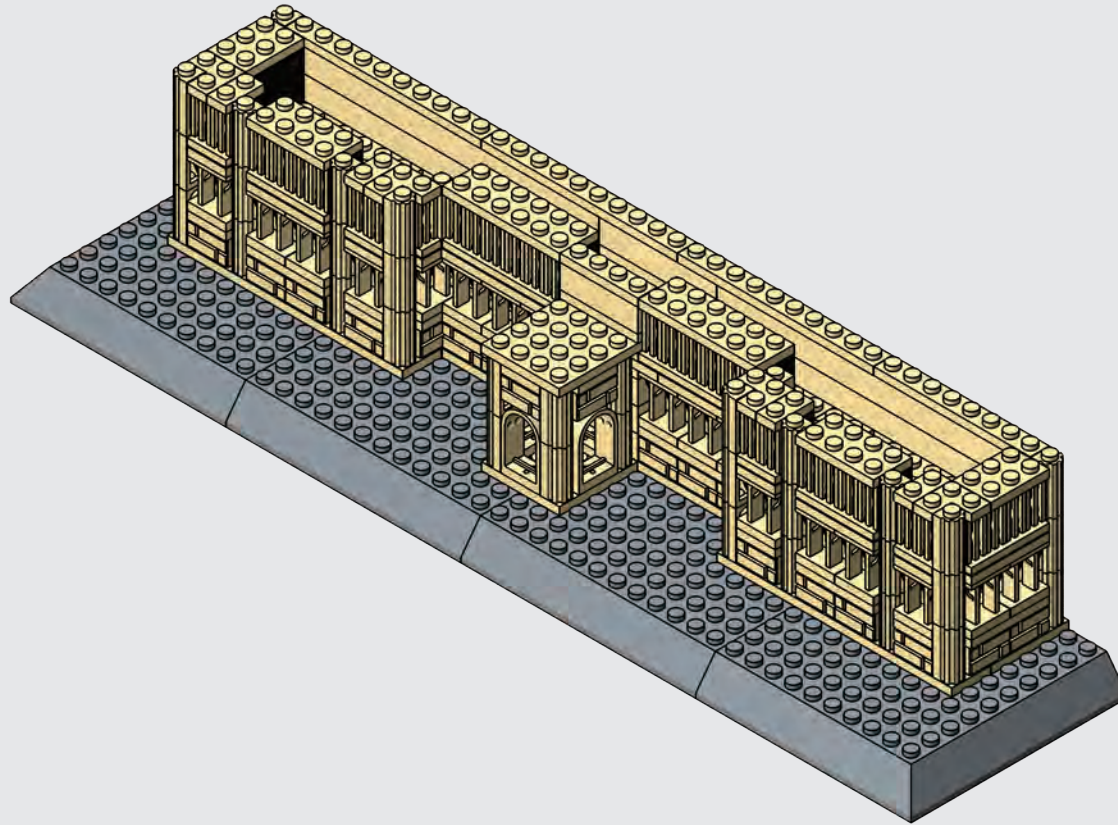

2

1-1

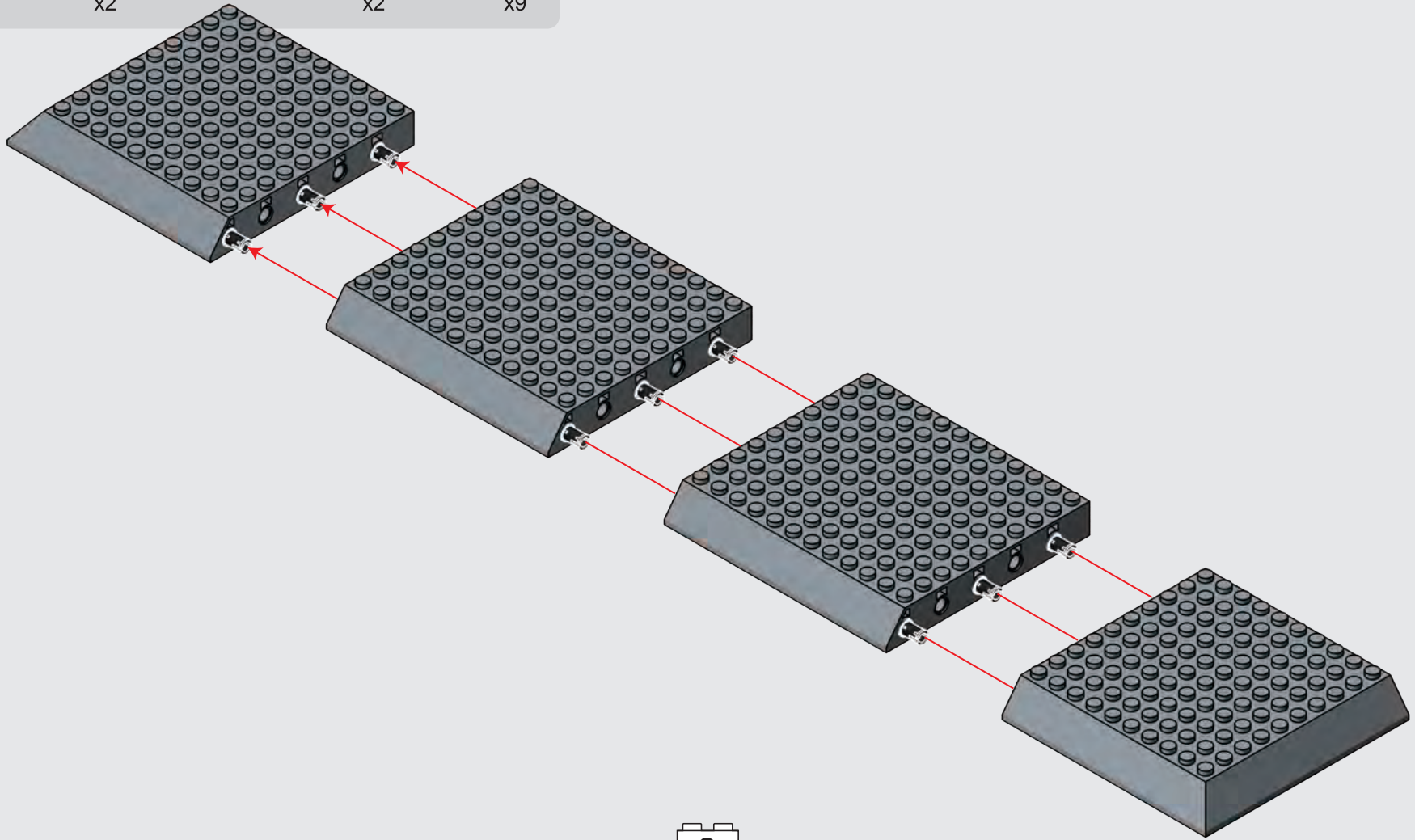
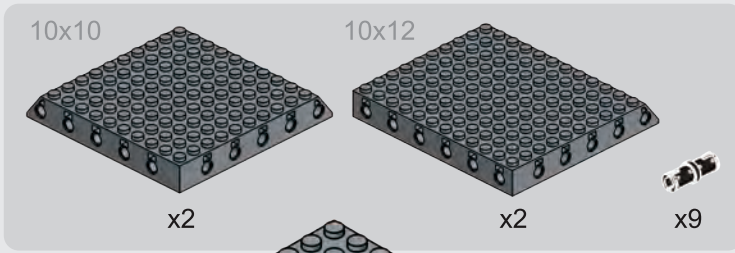



# 1-2

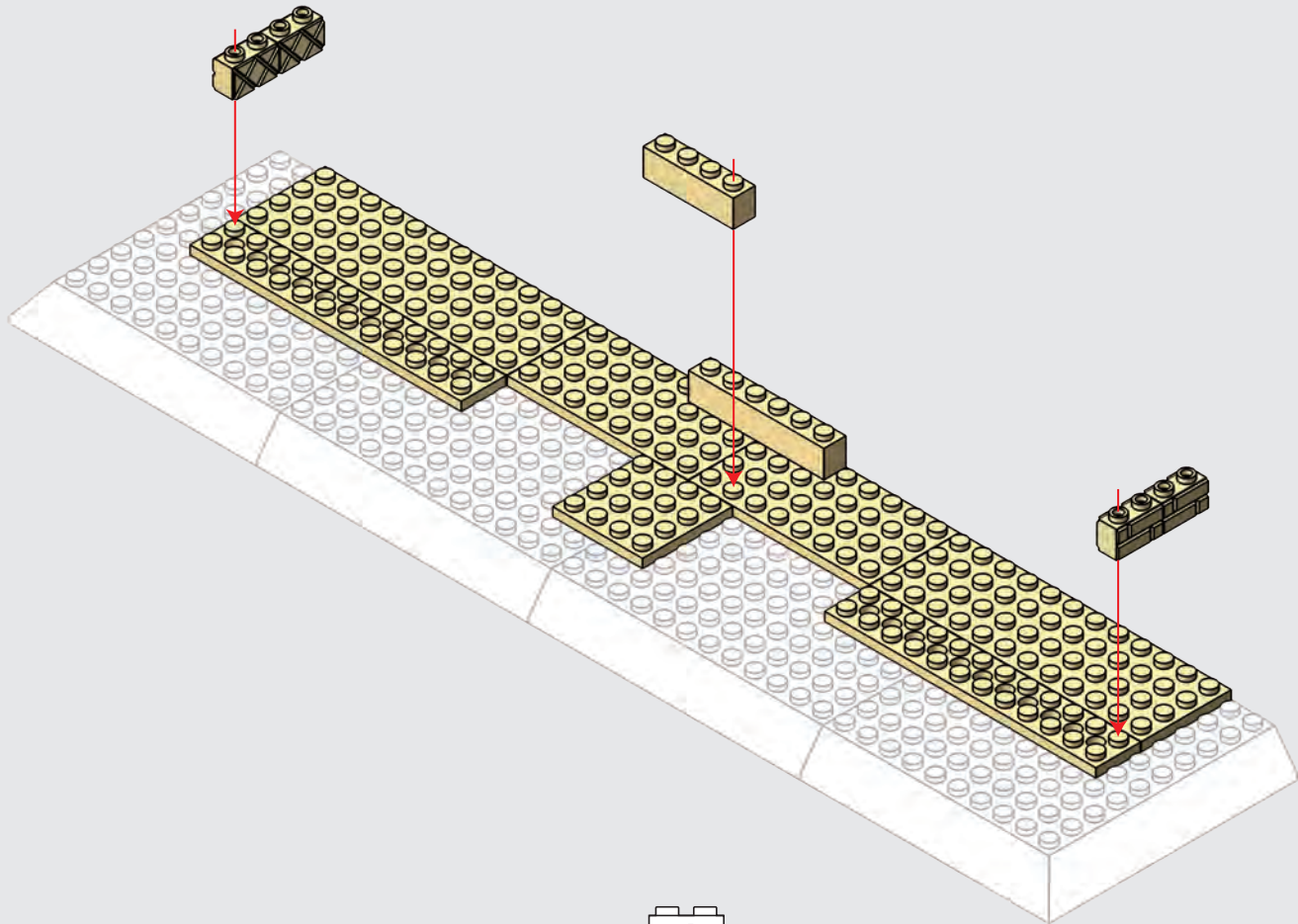
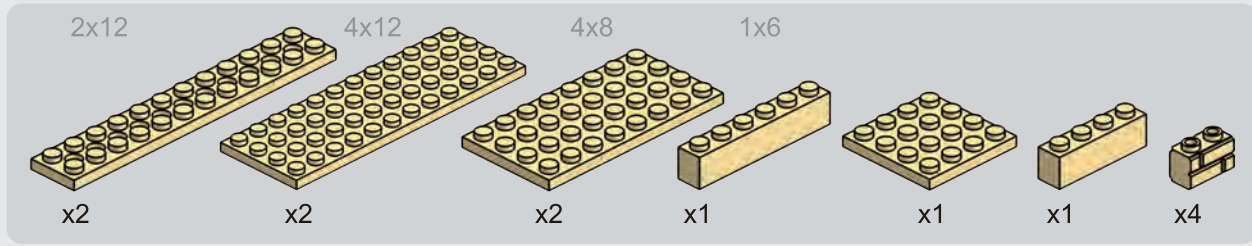

1-3

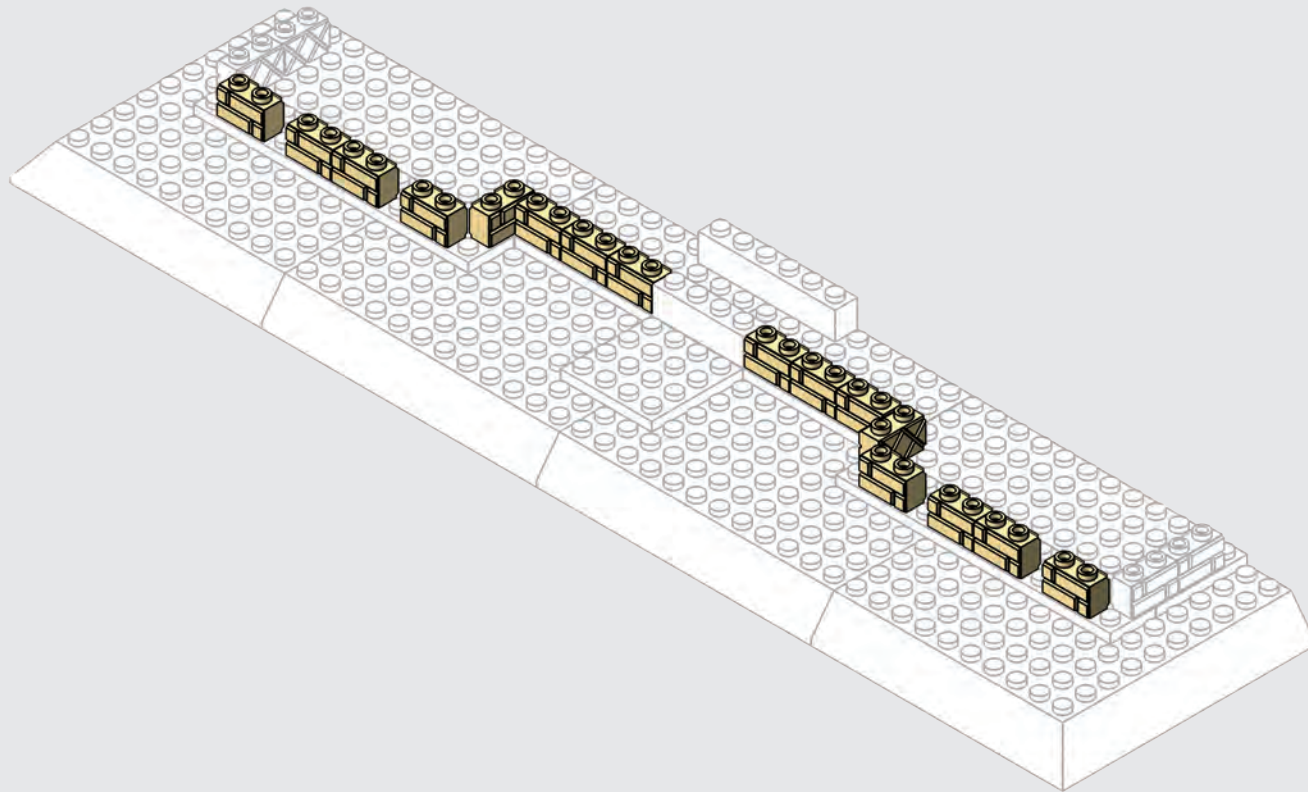

1-4

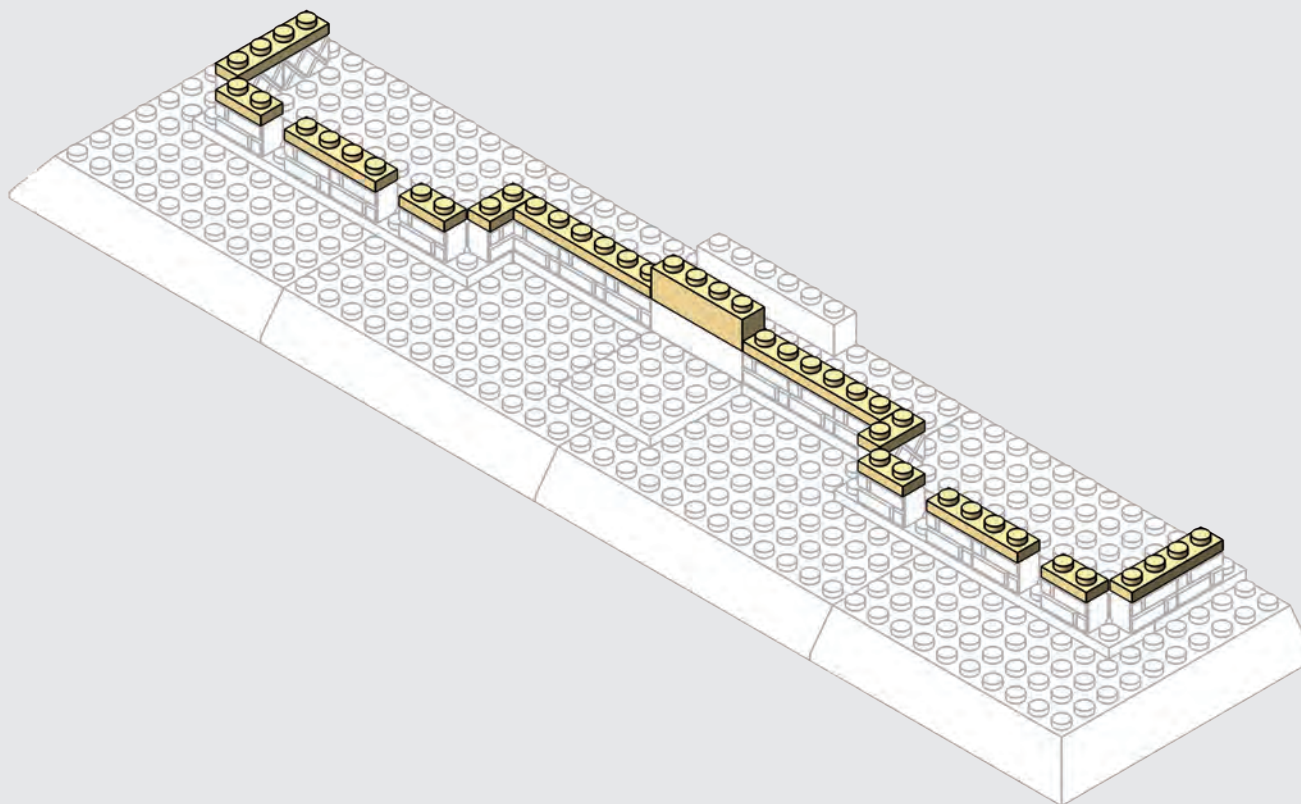
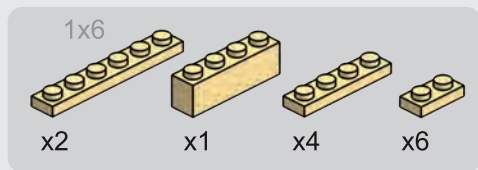



1-5

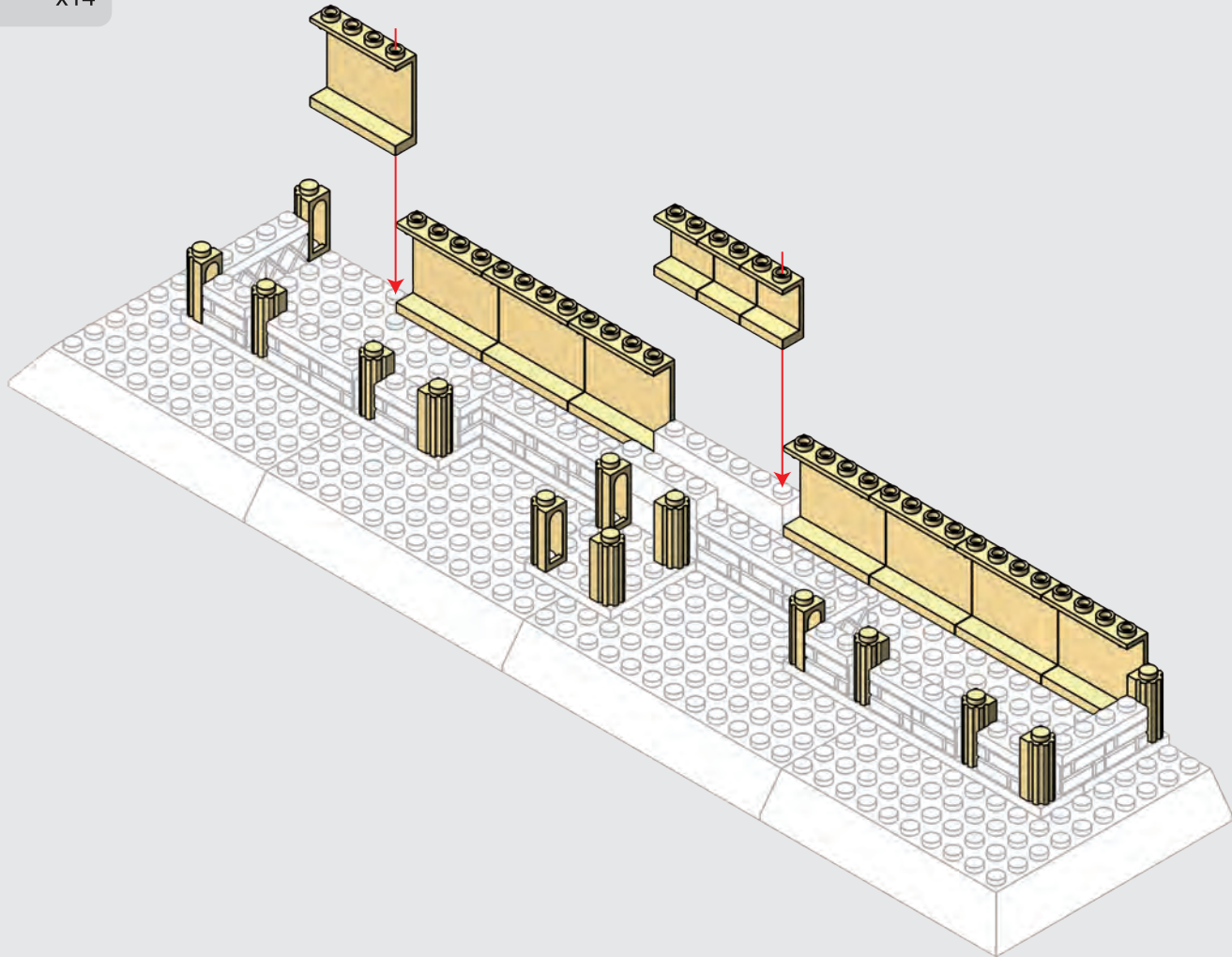
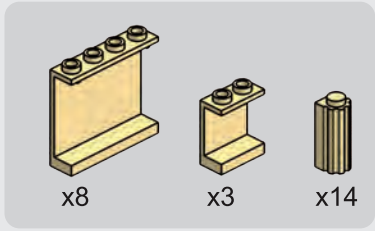

1-6



x4



x20

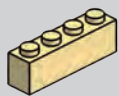

x1

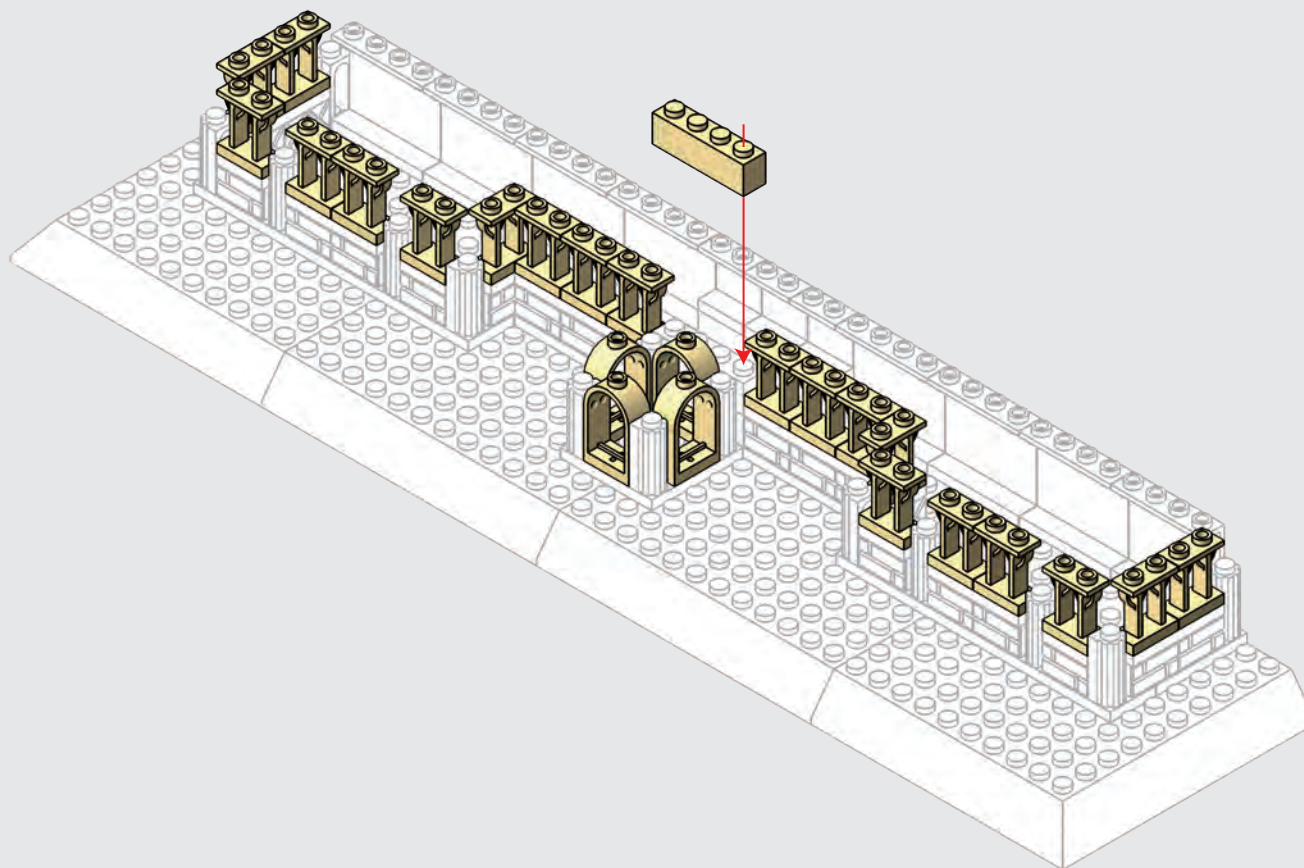

1-7

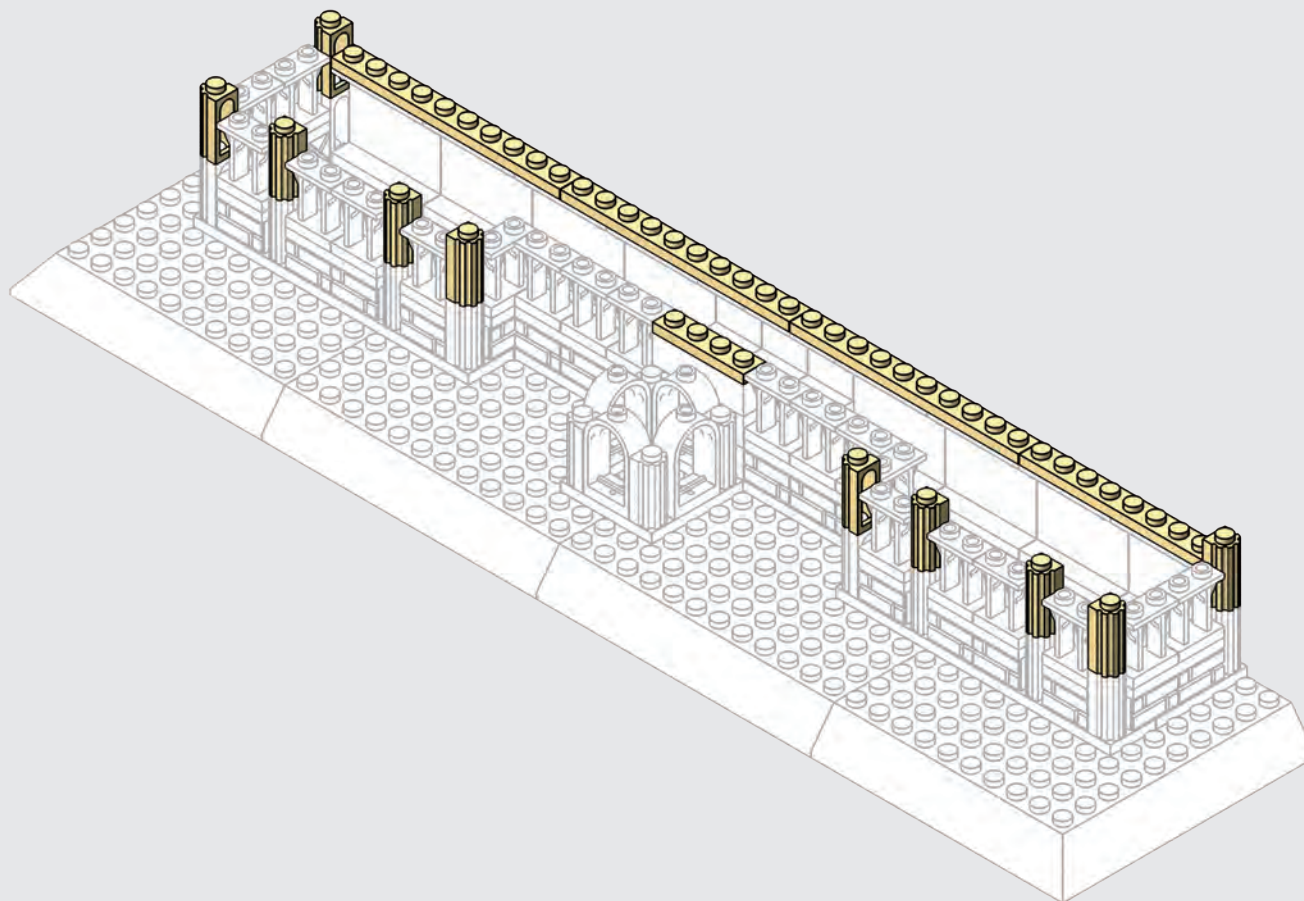
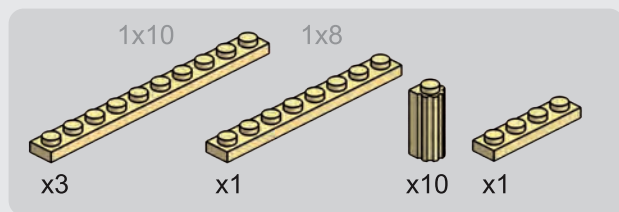



# 1-8

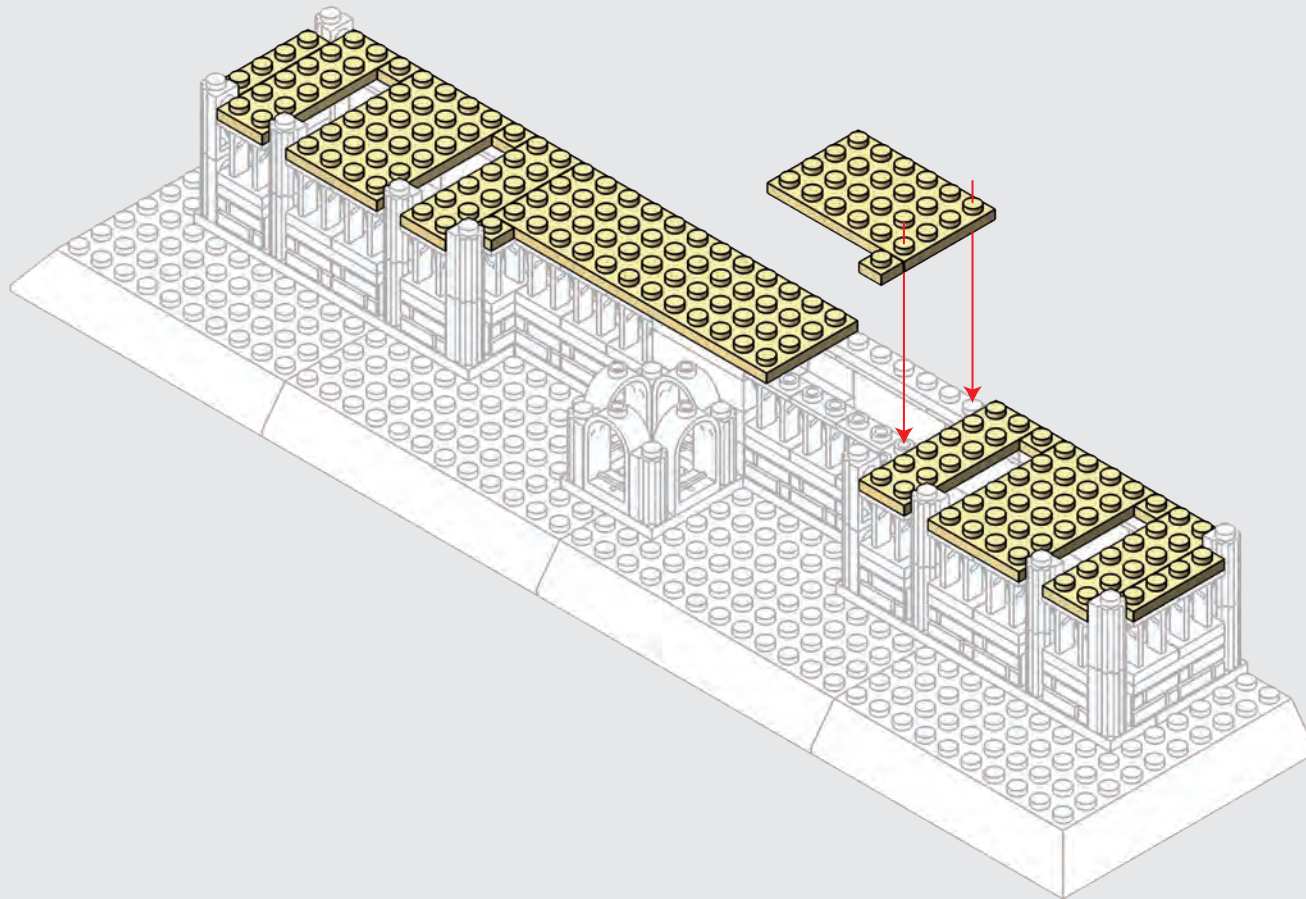
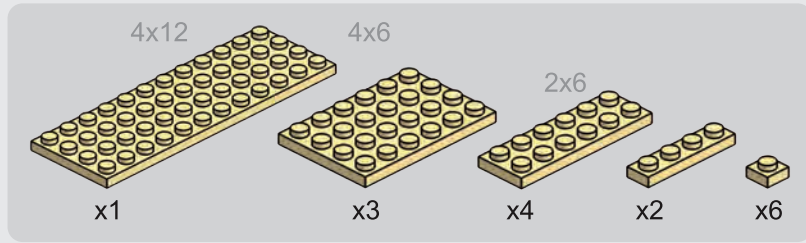

# 1-9

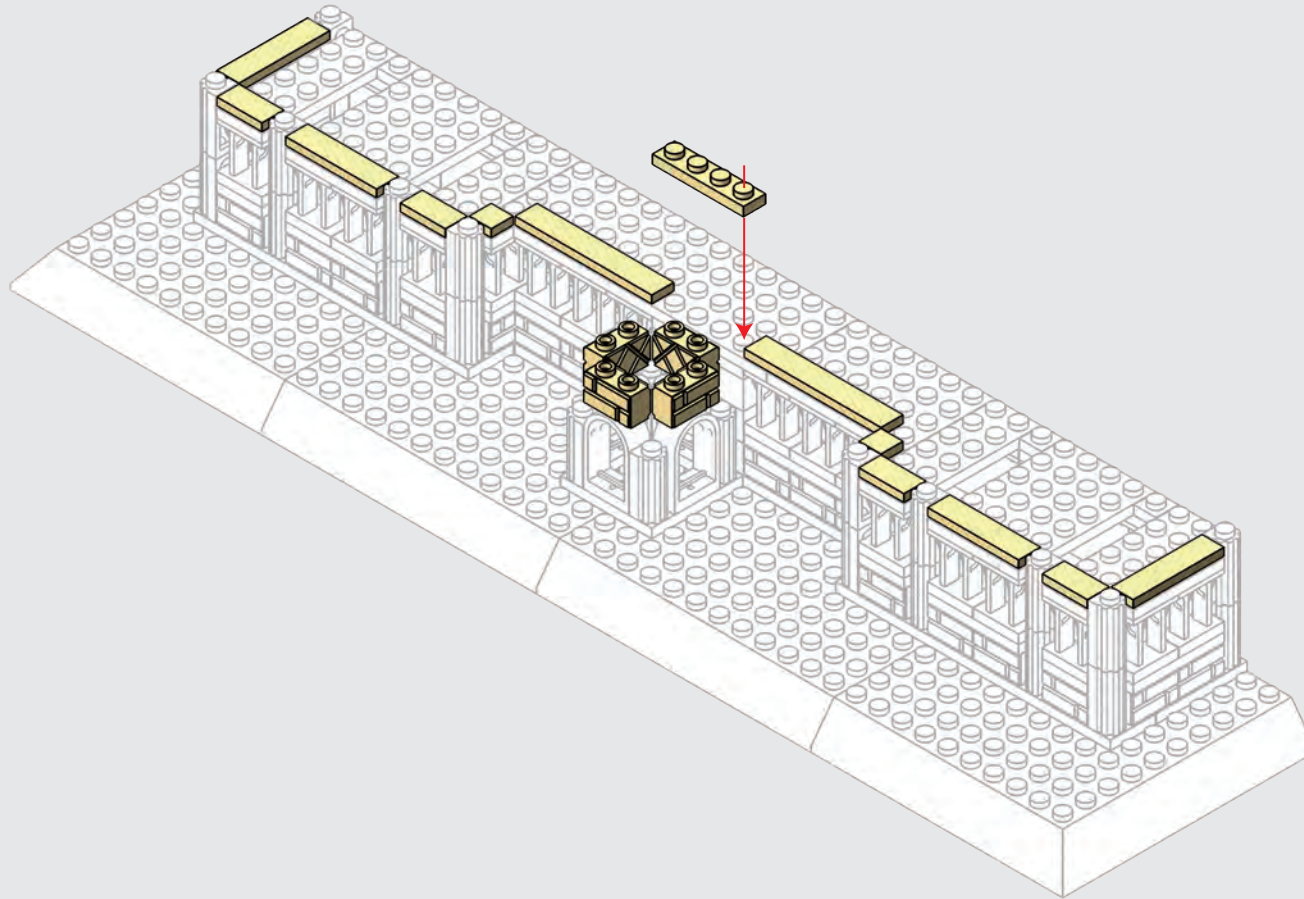
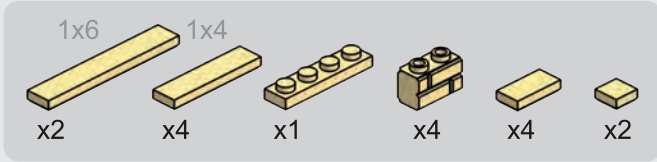

1-10

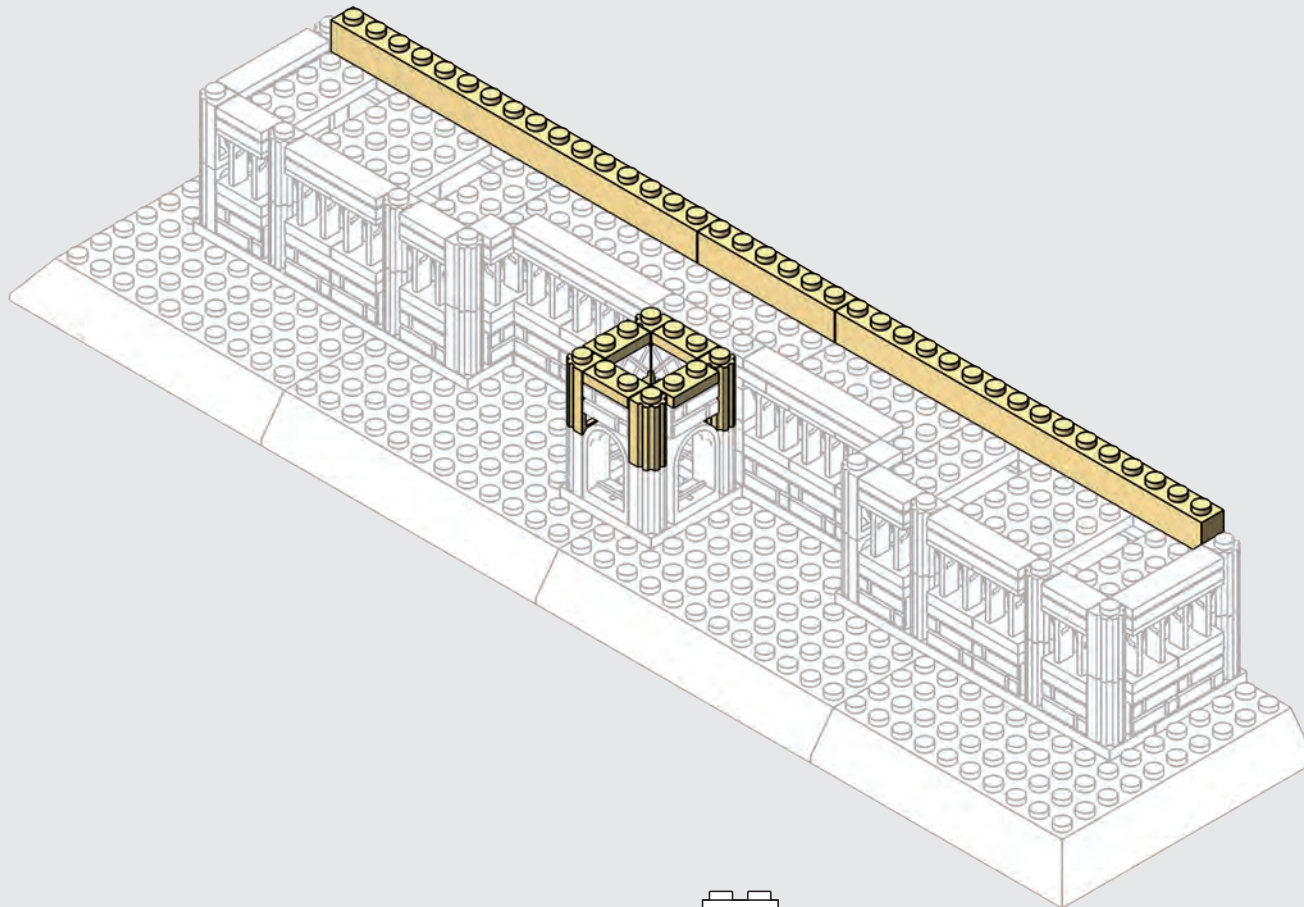
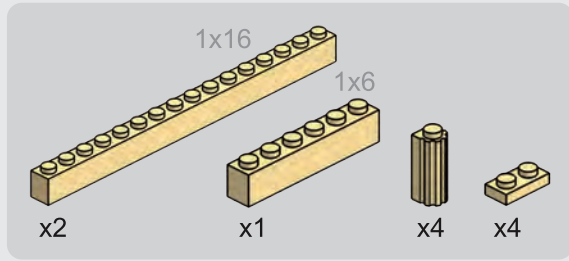



# 1-11

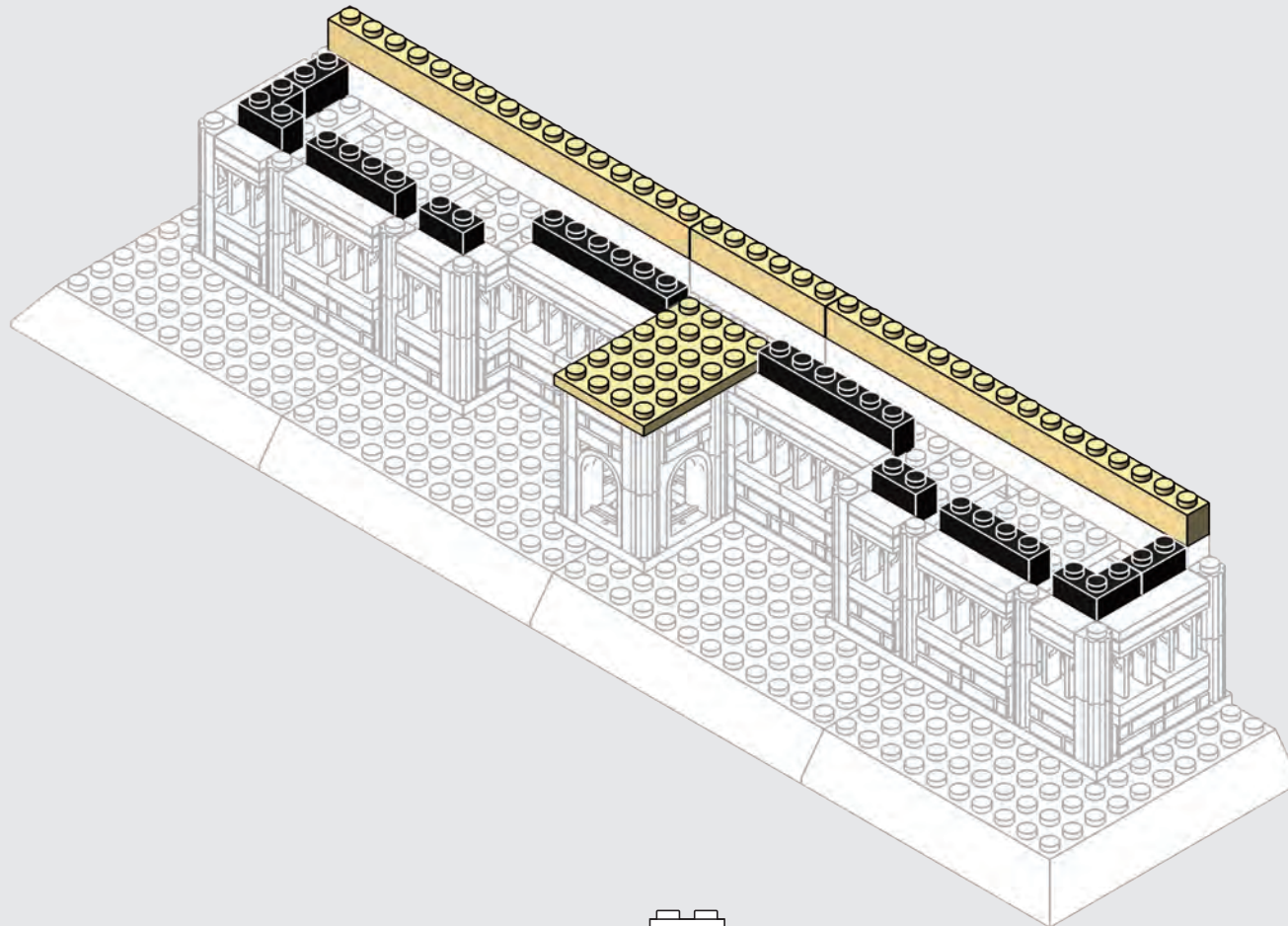
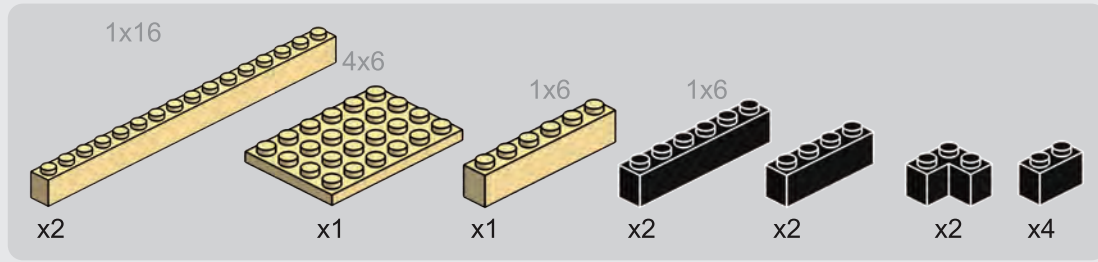

1-12

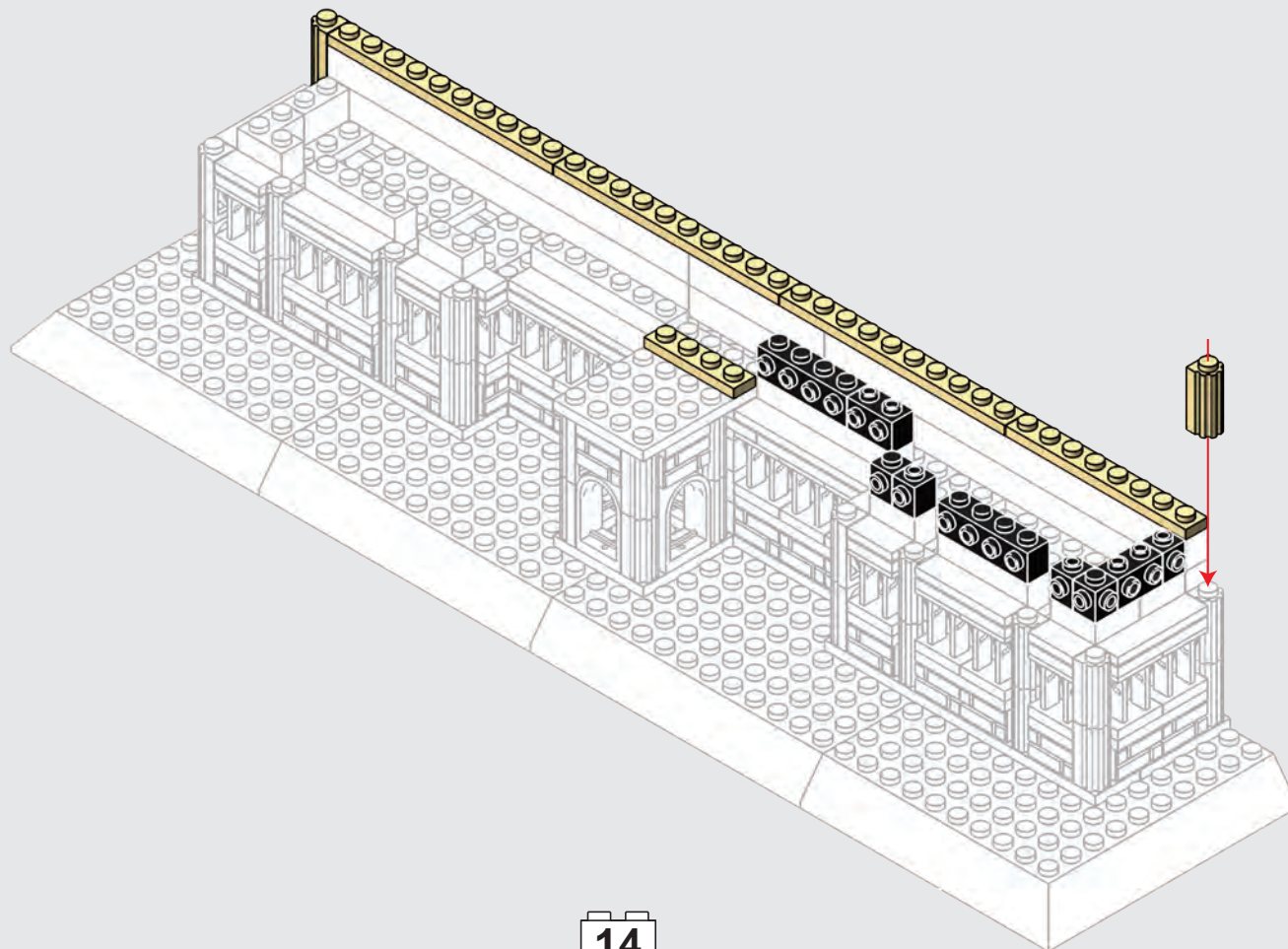
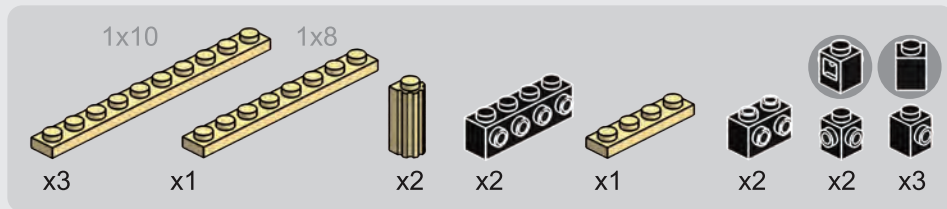

1-13



x2

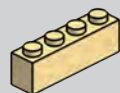

x1



x2



x1



x2



x2



x3



x1

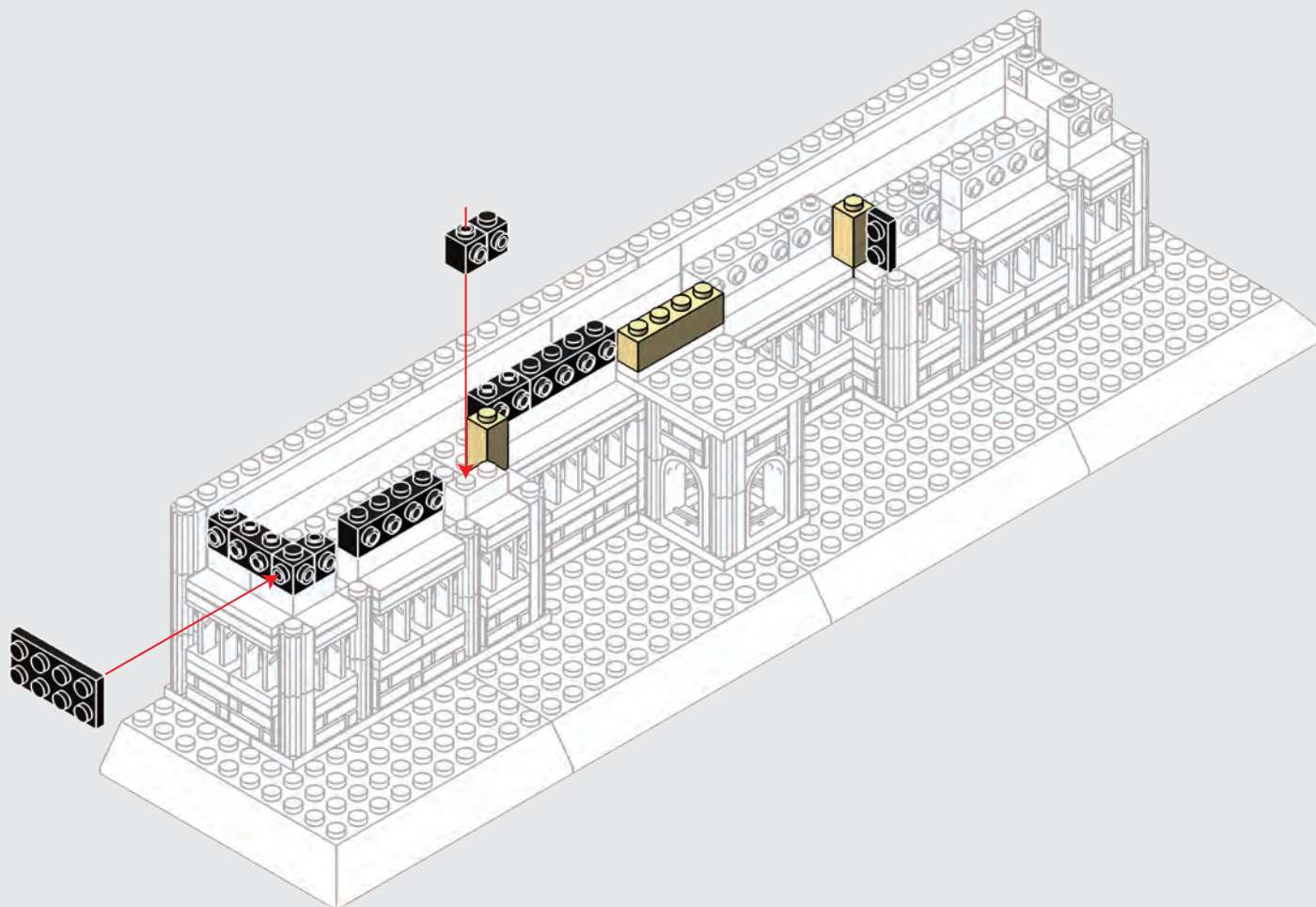



1-14

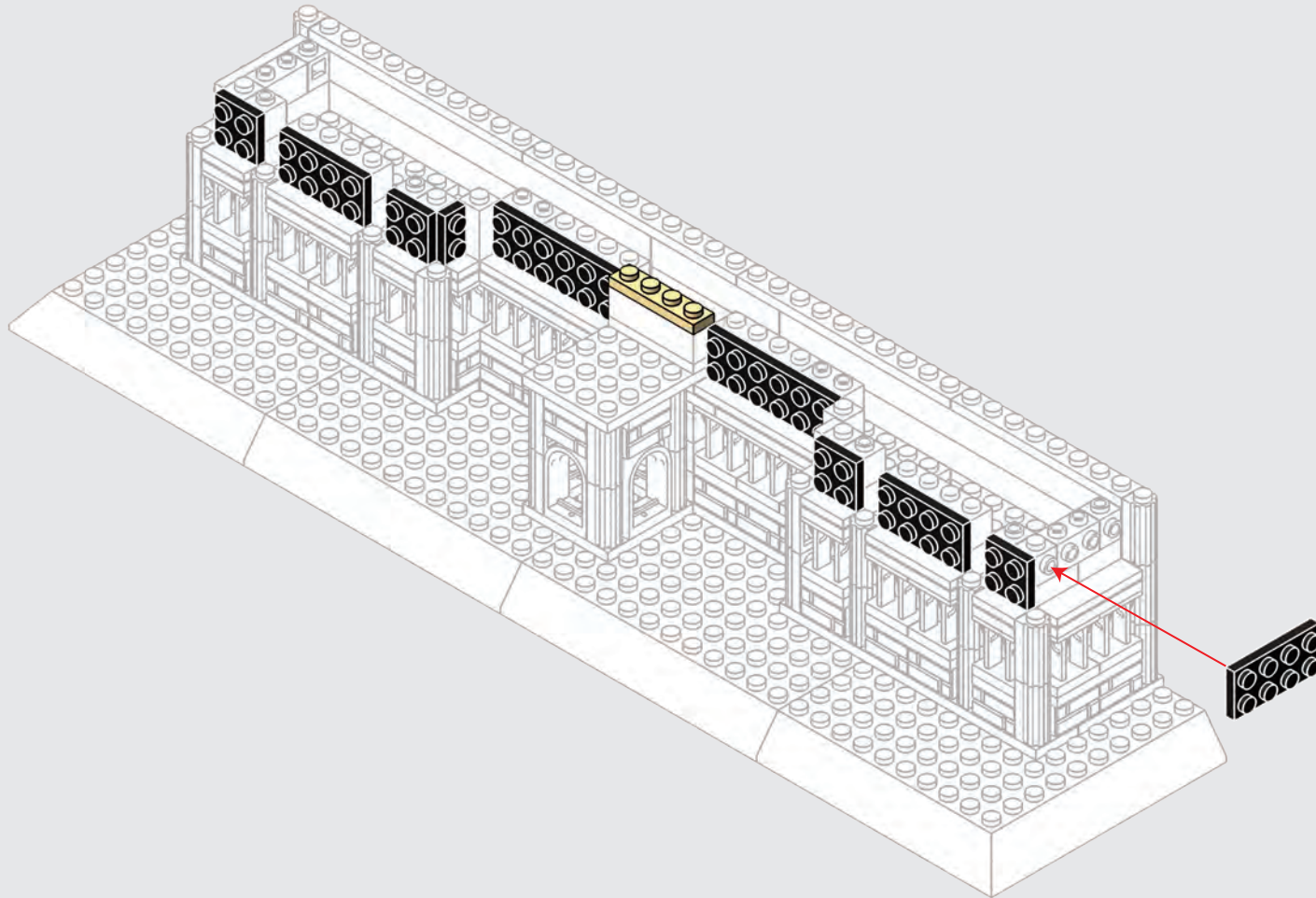
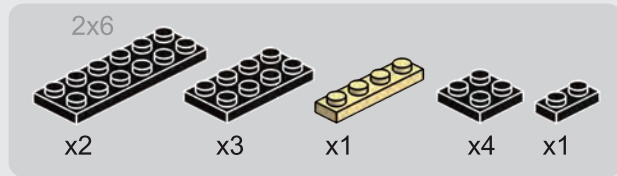

1-15



x8



x38

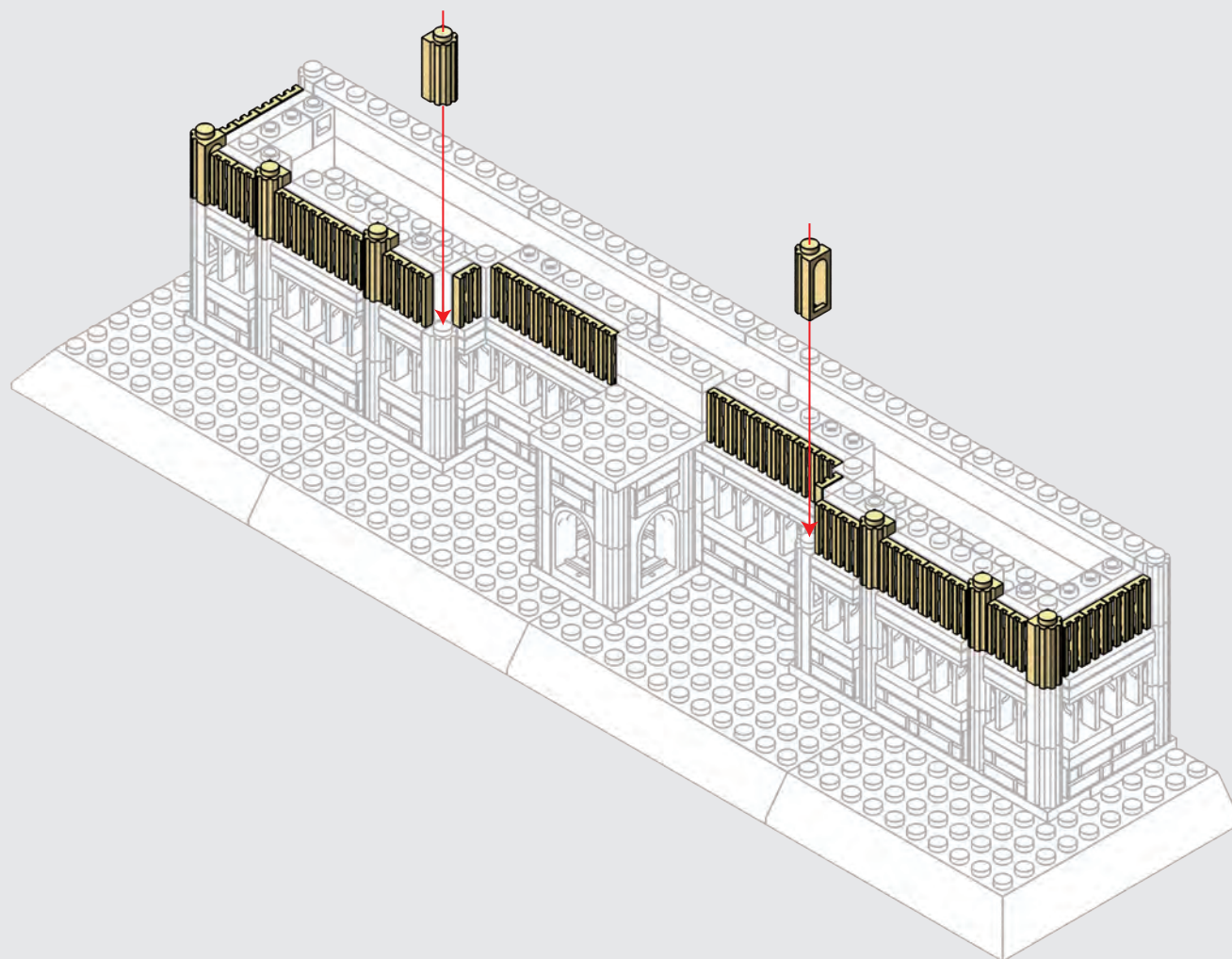

1-16

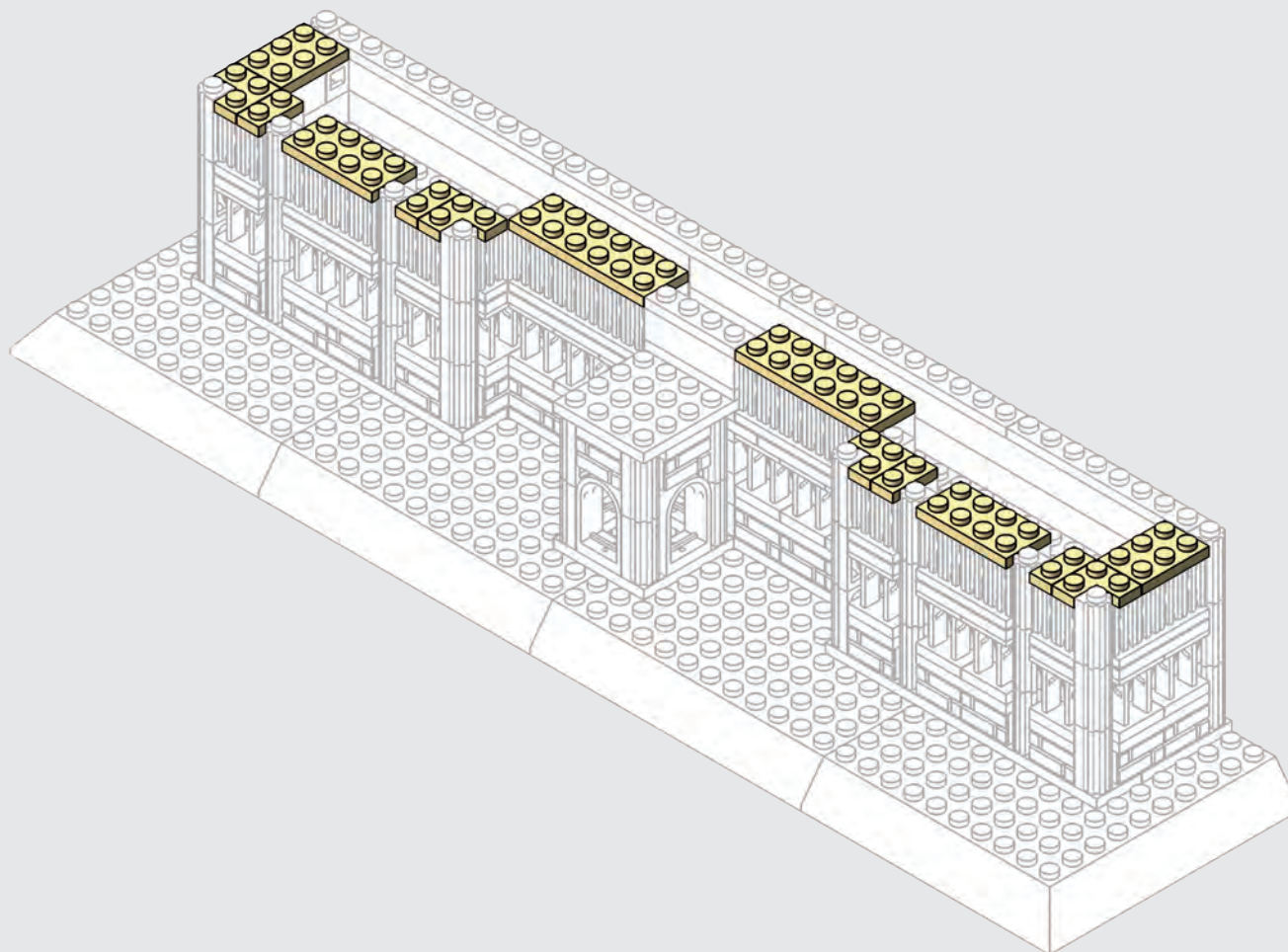
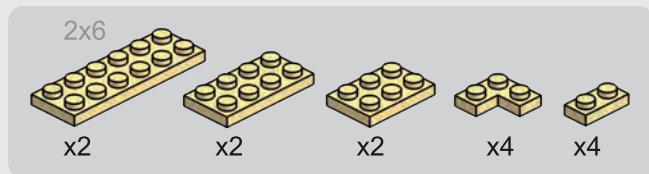





186PCS

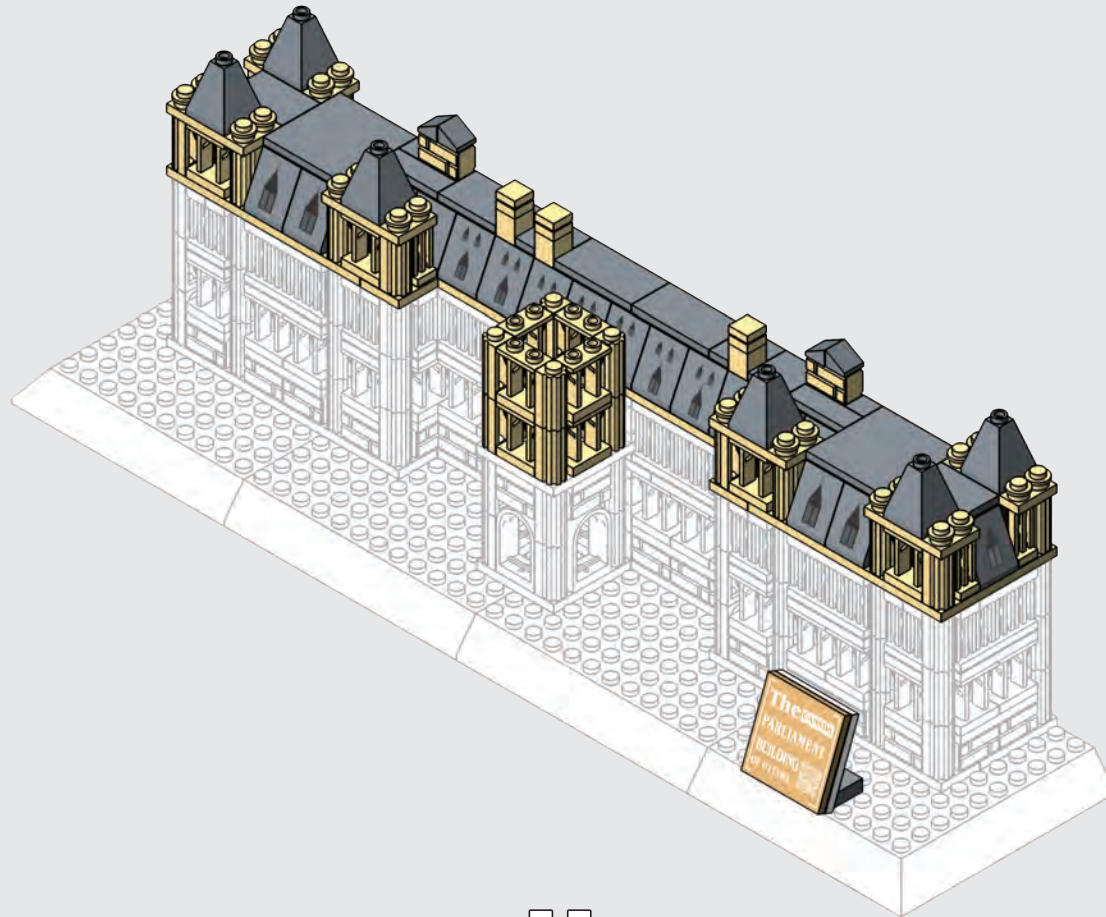

2-1

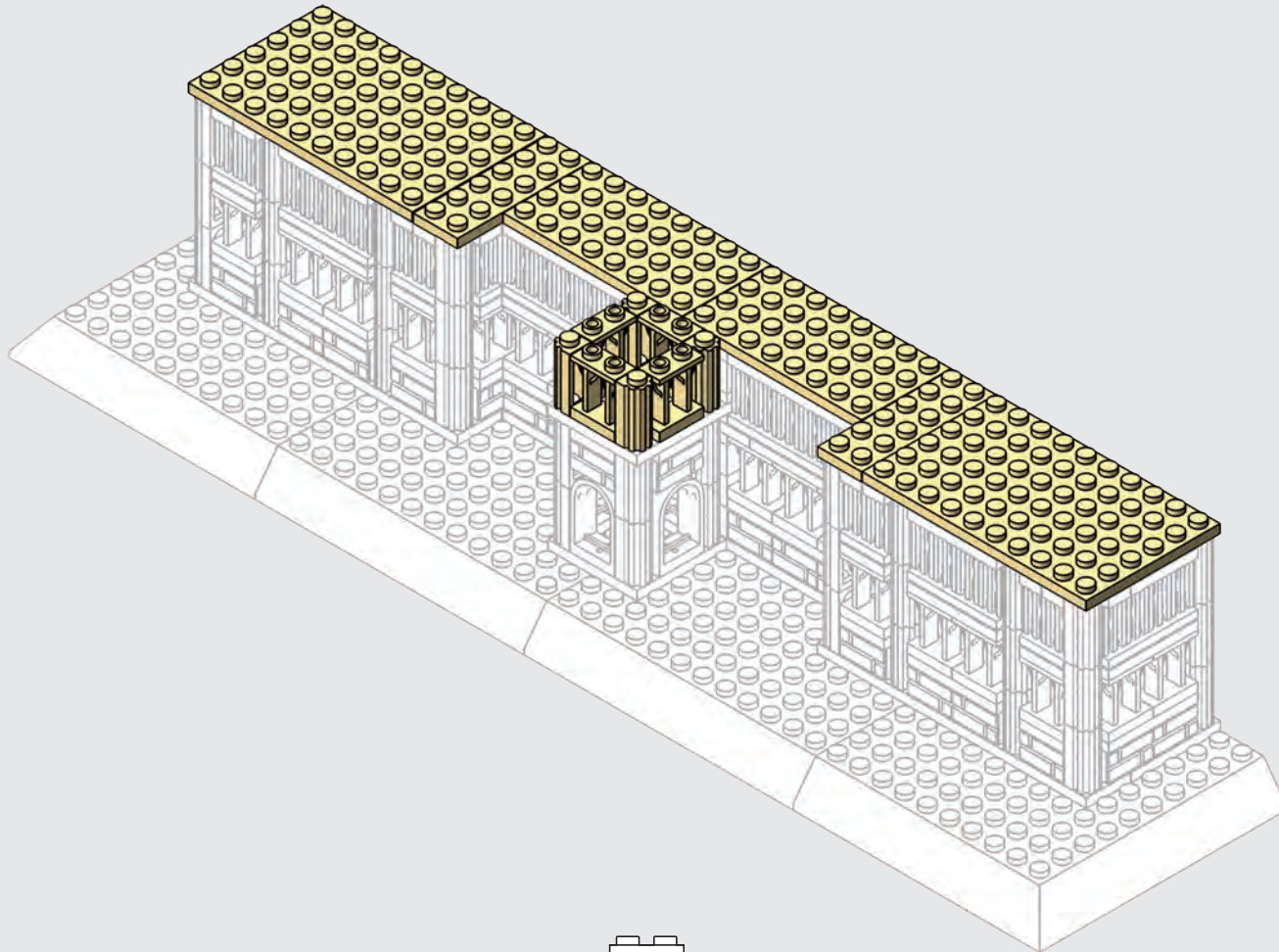
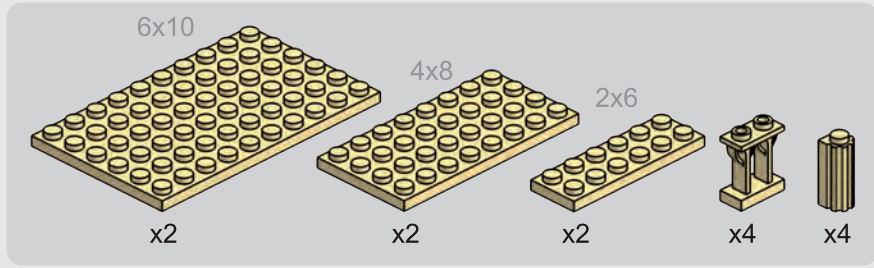

2-2

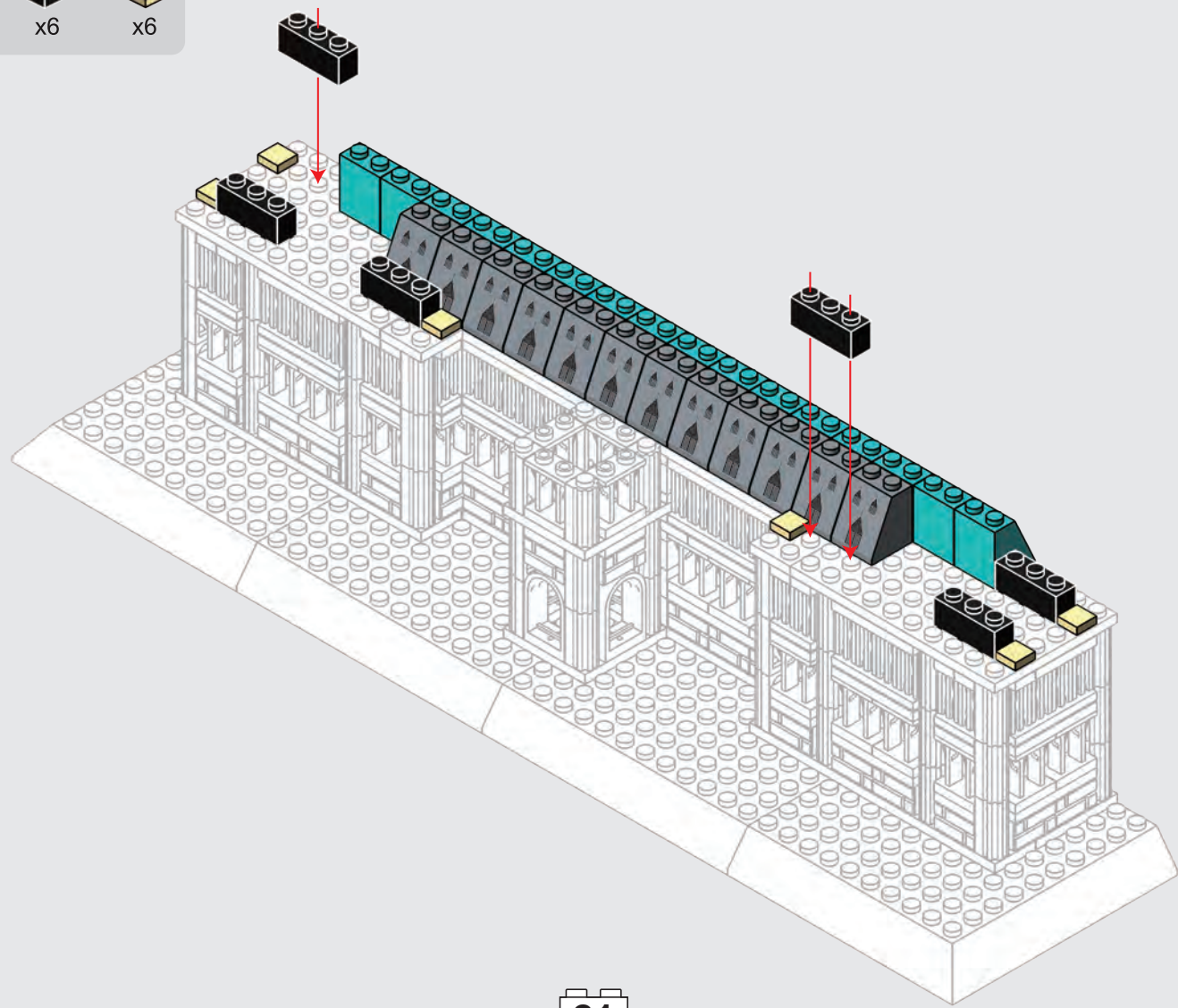



2-3

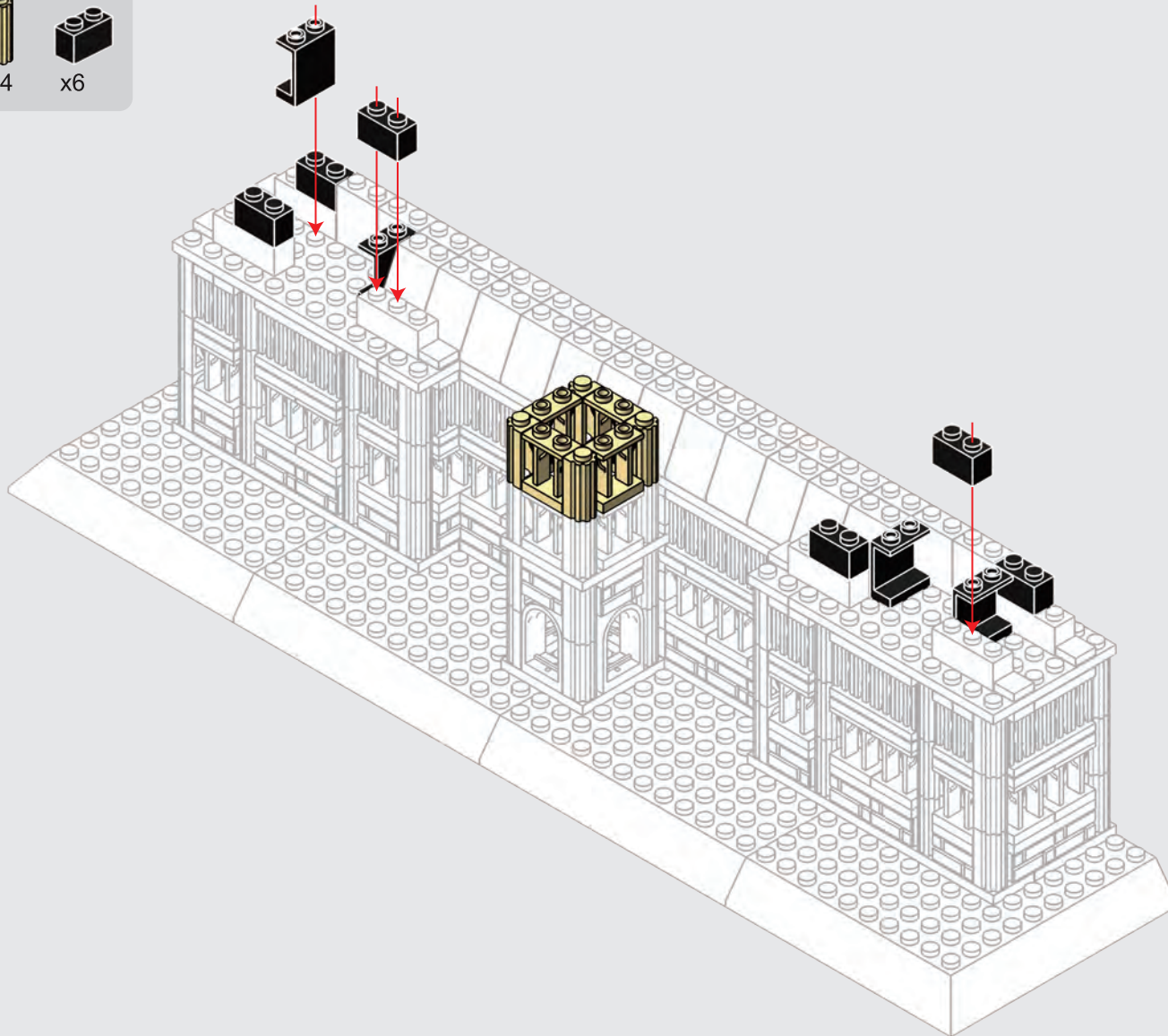
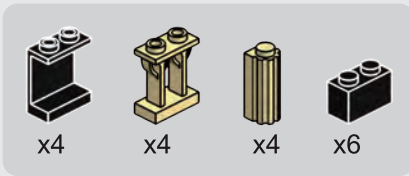

2-4

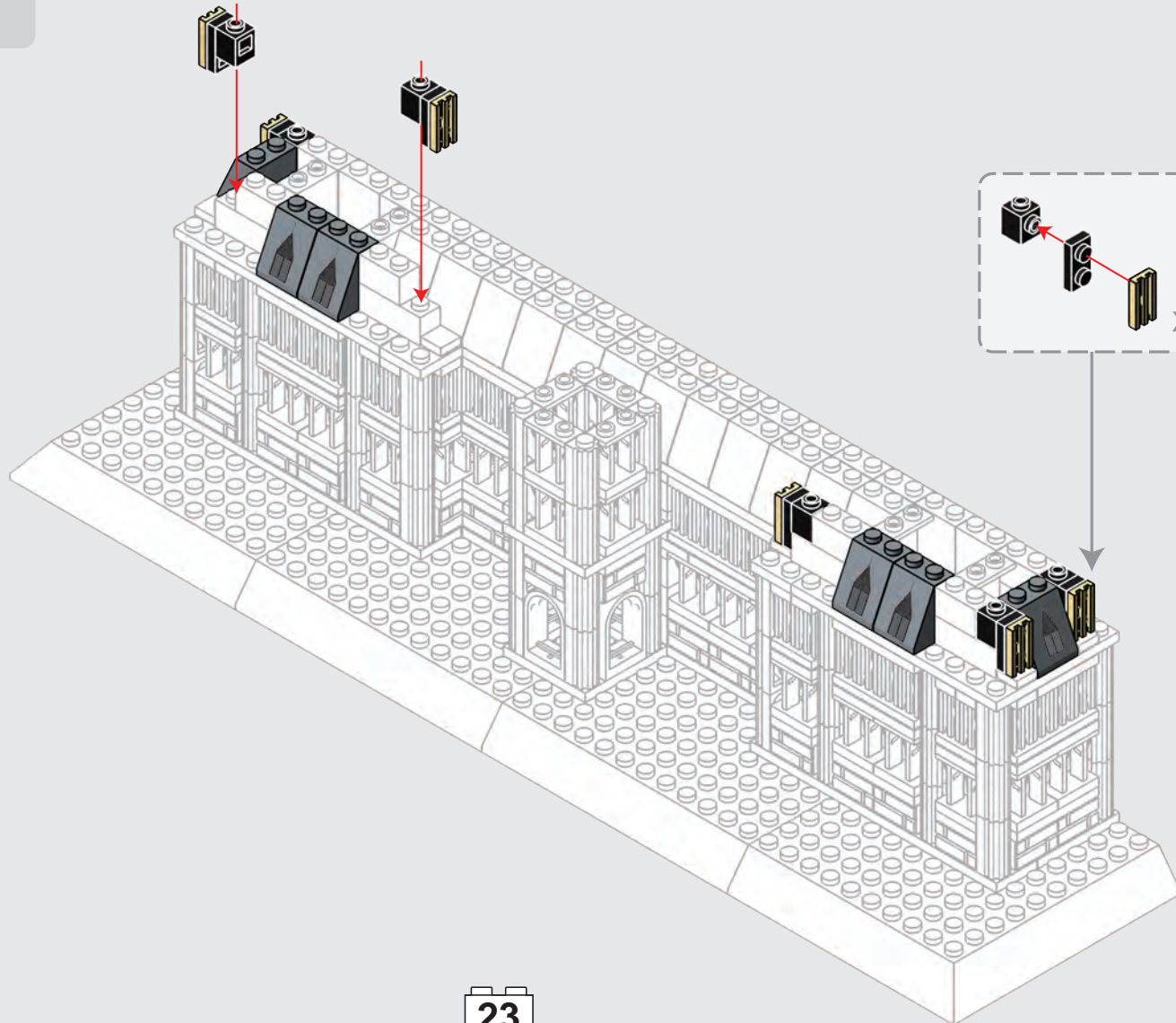
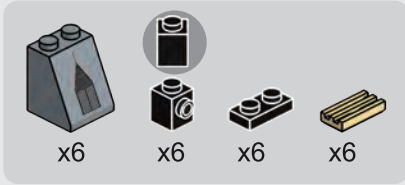

2-5

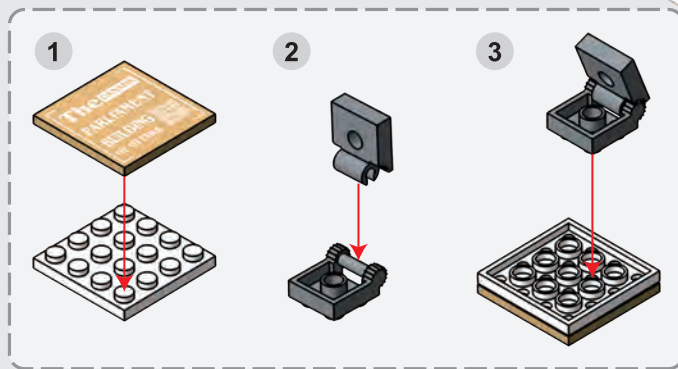
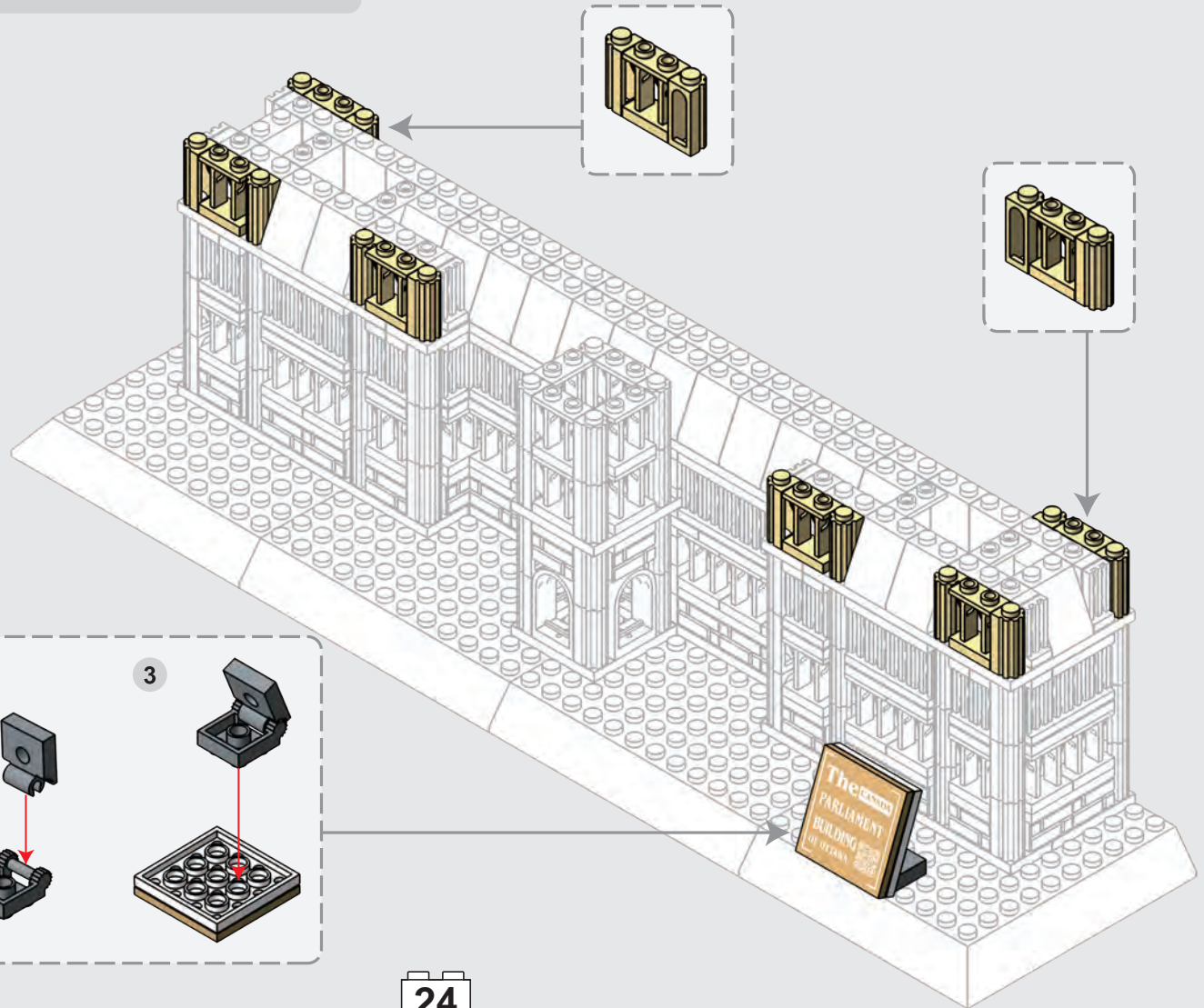
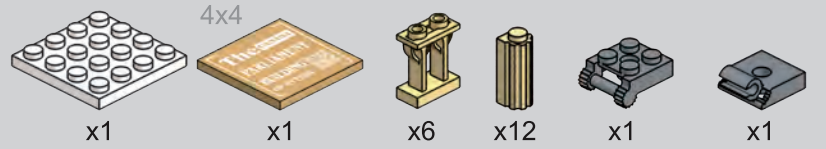



# 2-6

4x4 x2    2x3 x3    1x3 x2    1x3 x2    1x2 x2    1x1 x2

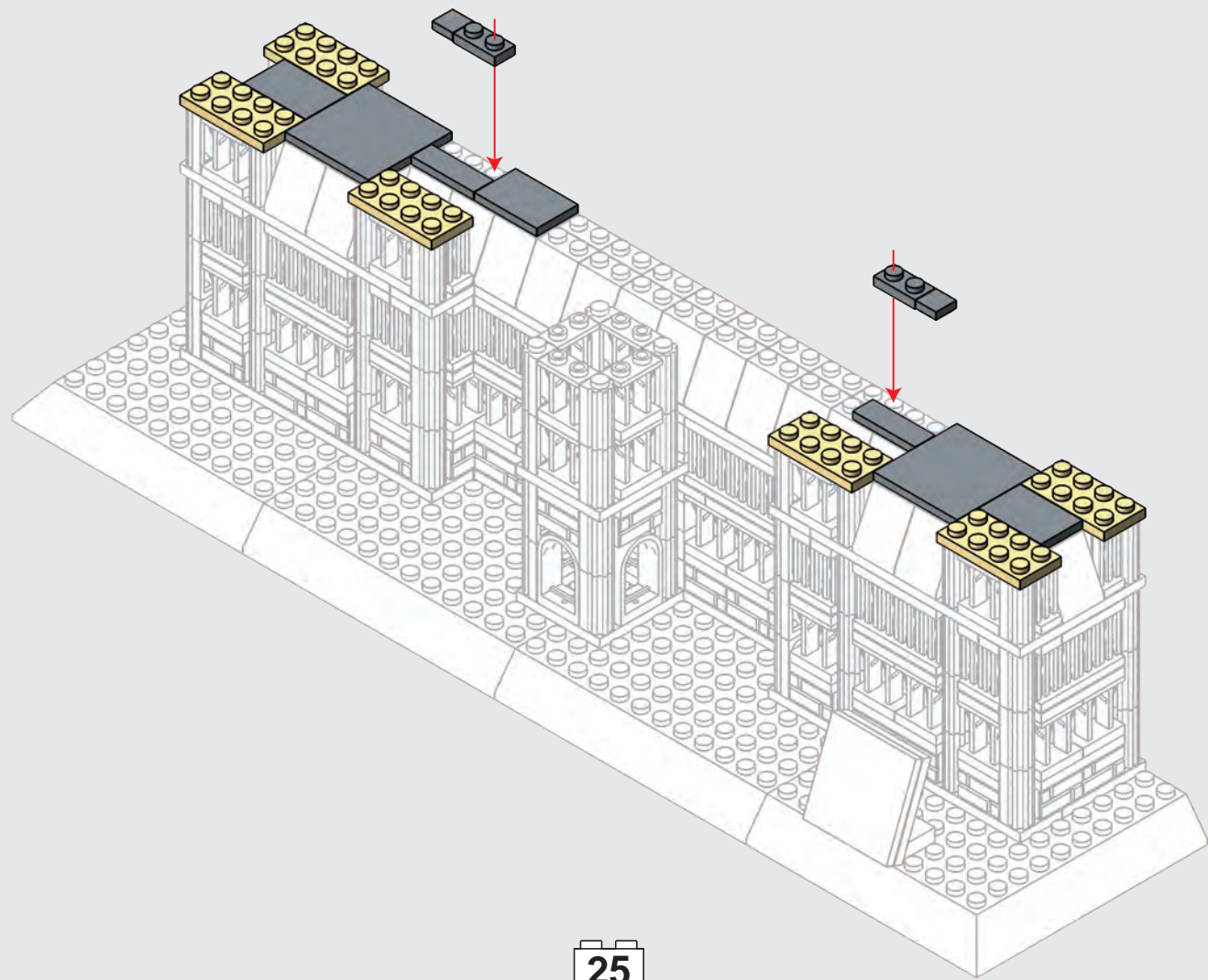

2-7

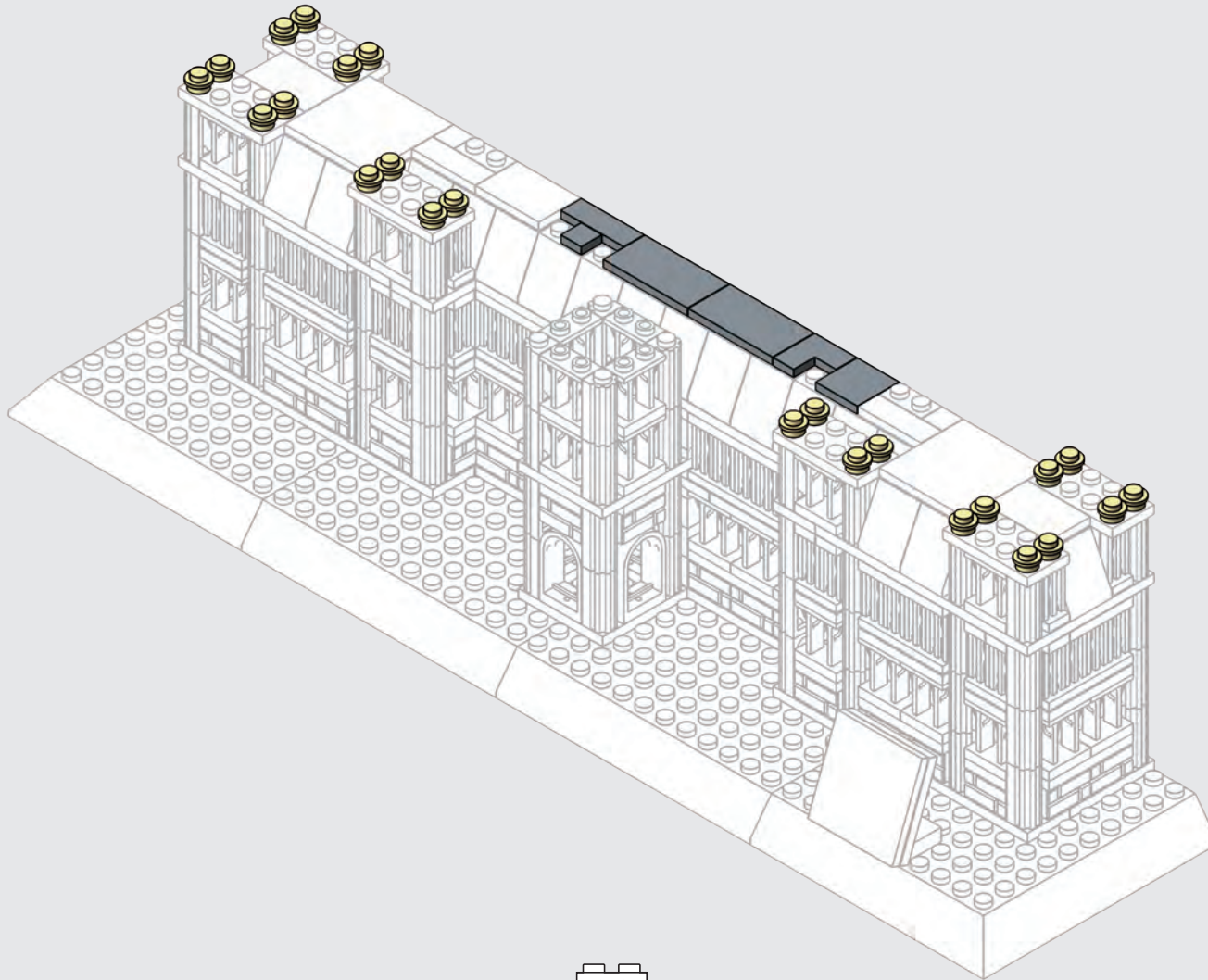
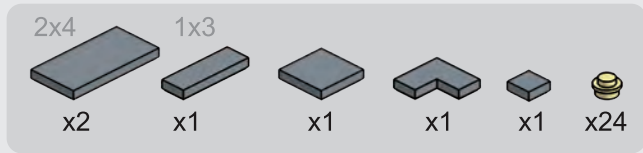

2-8

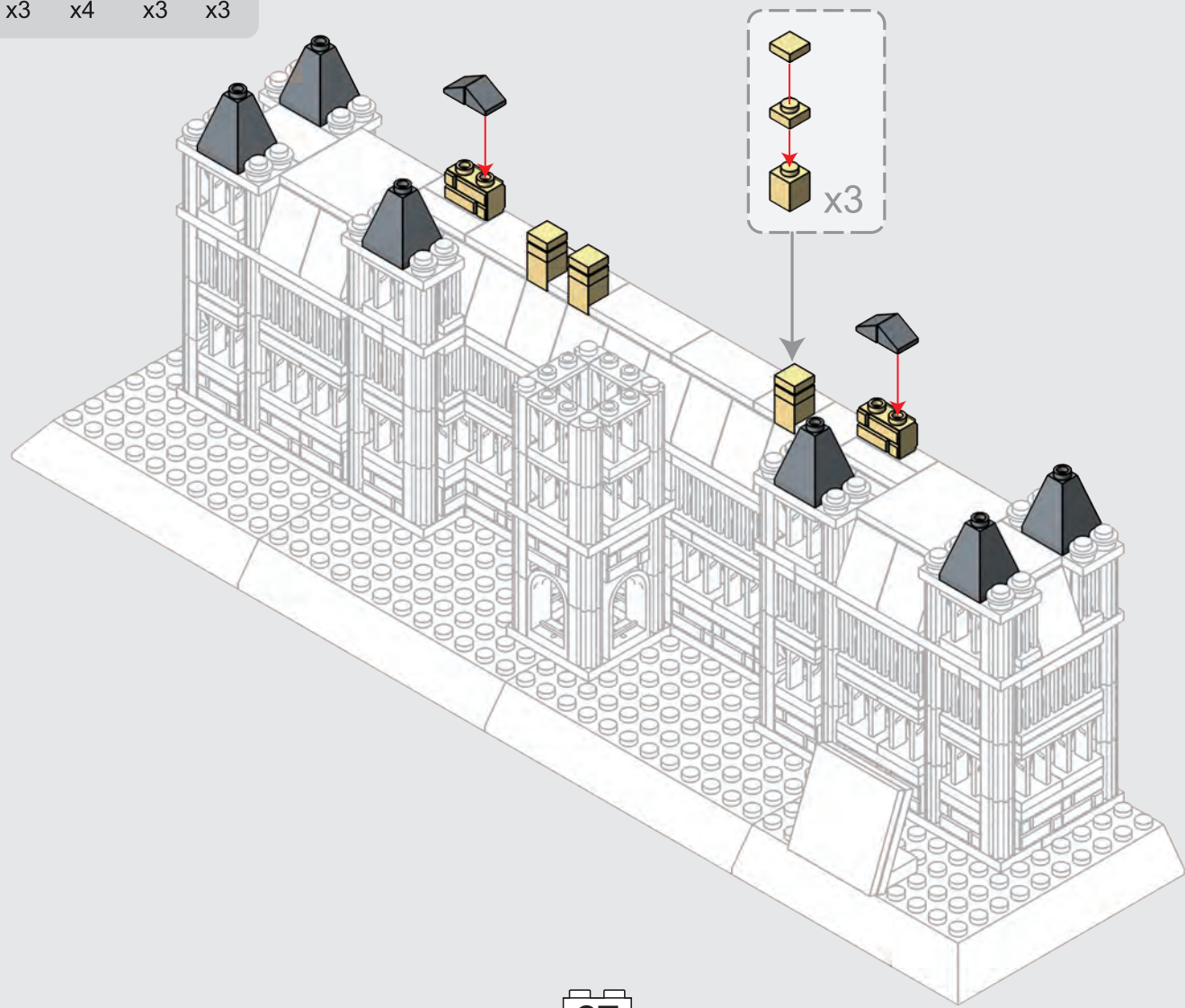
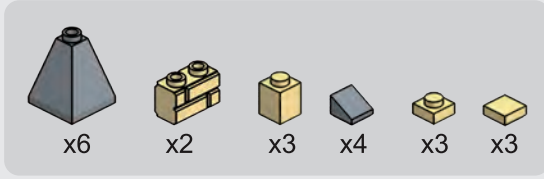





**143**PCS

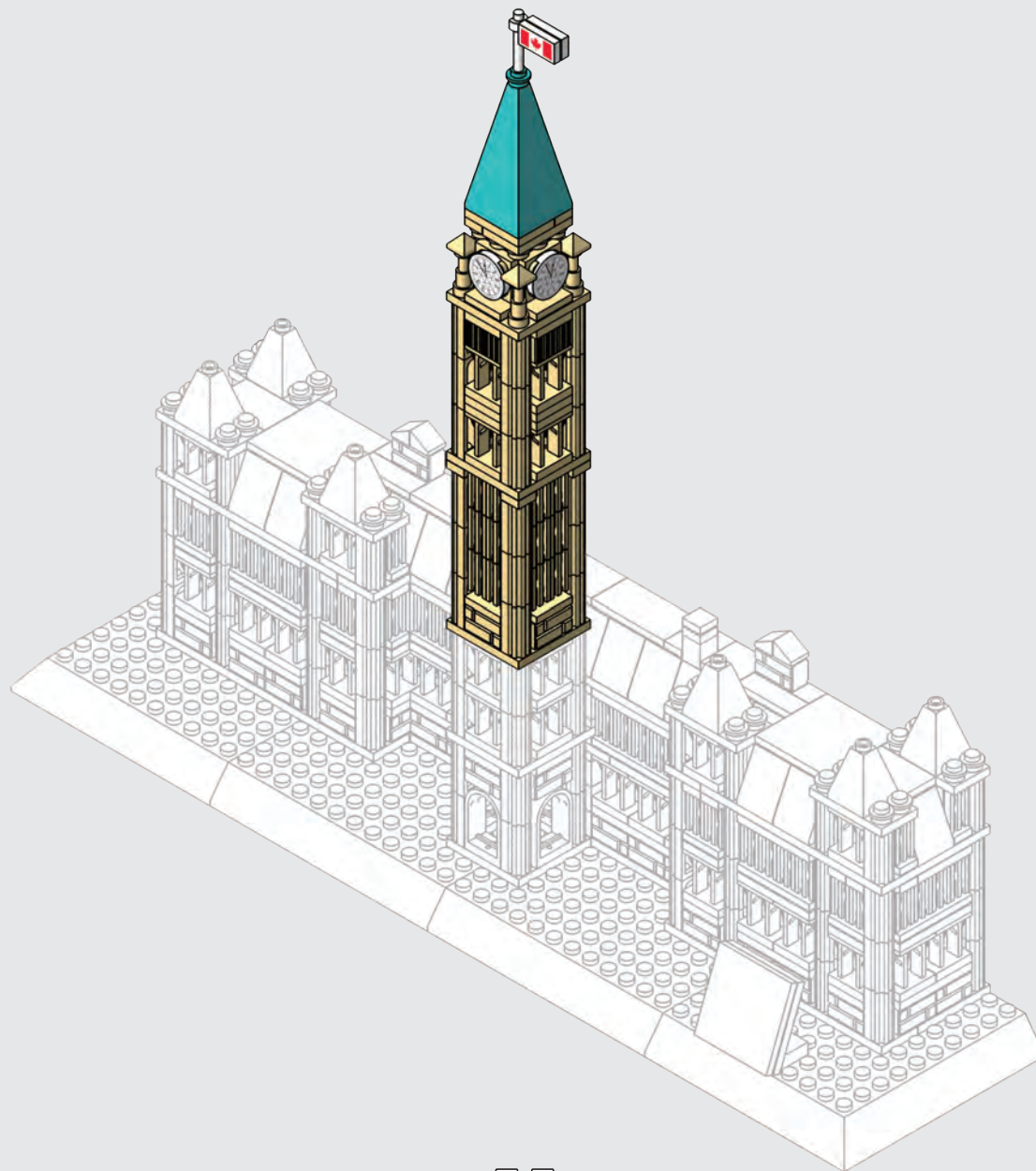

**28**

### 3-1

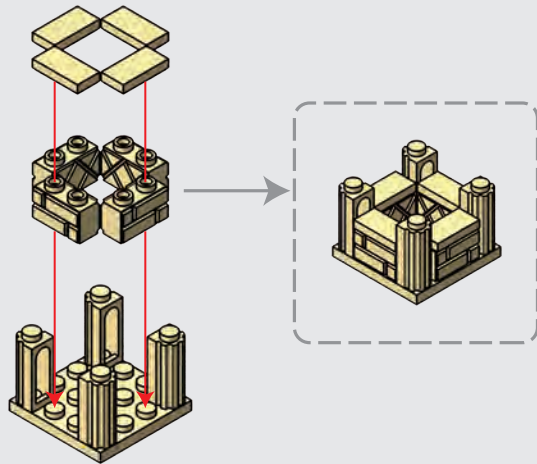
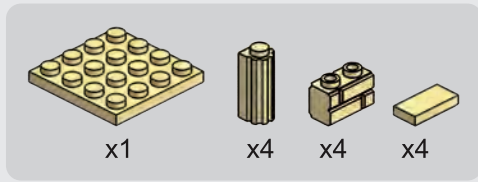

### 3-2

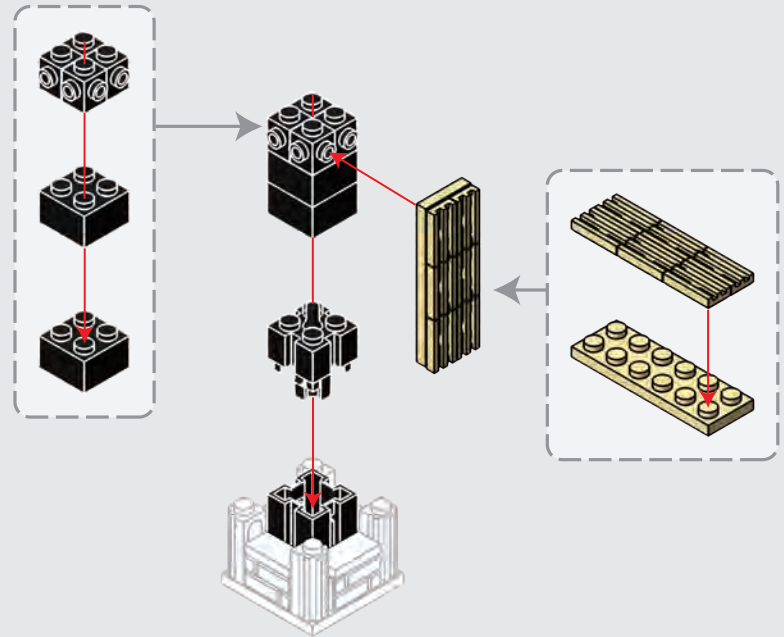
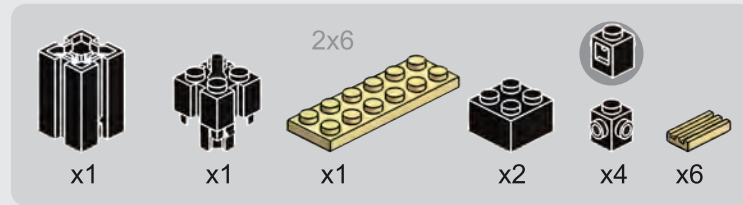

3-3

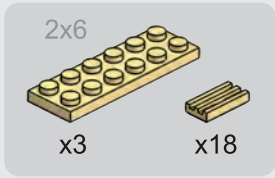

3-4

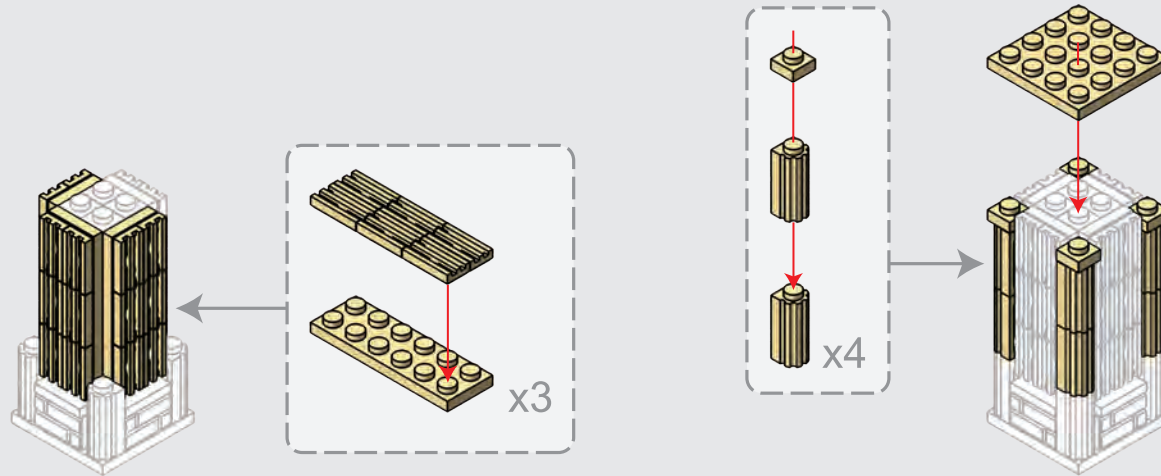
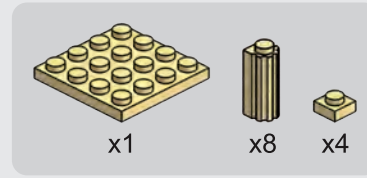



3-5

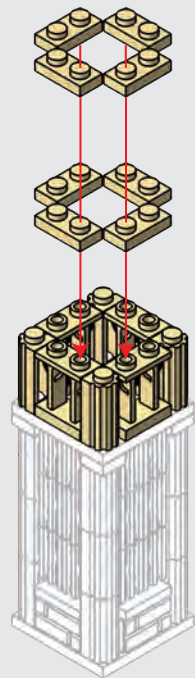
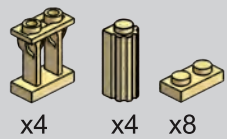

3-6

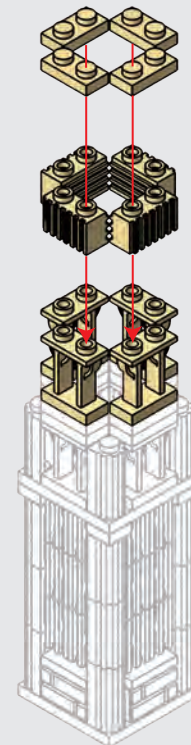
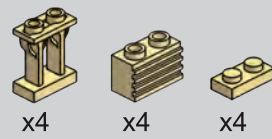

3-7

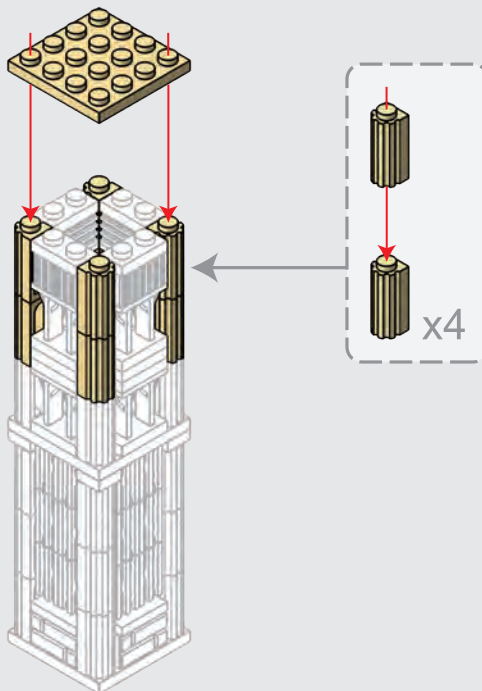
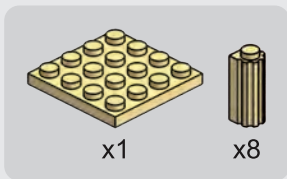

3-8

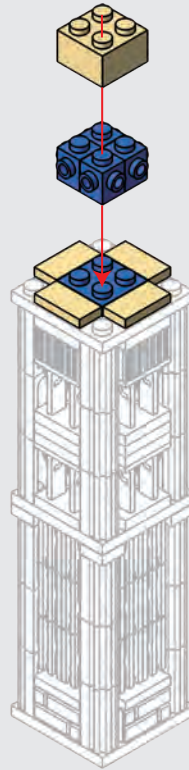
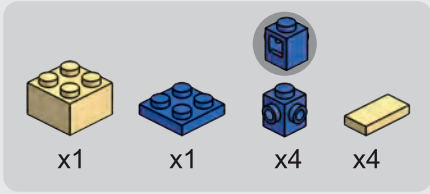



3-9



x4



x4

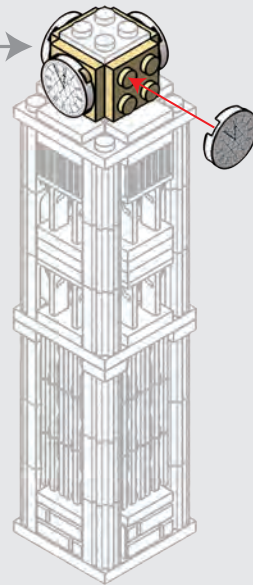
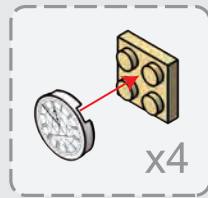

3-10



x4



x4

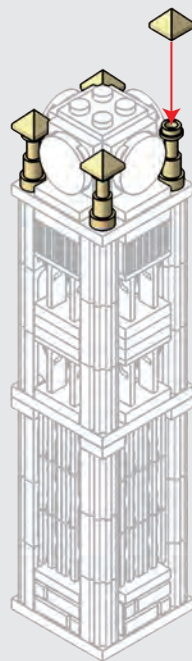

3-11

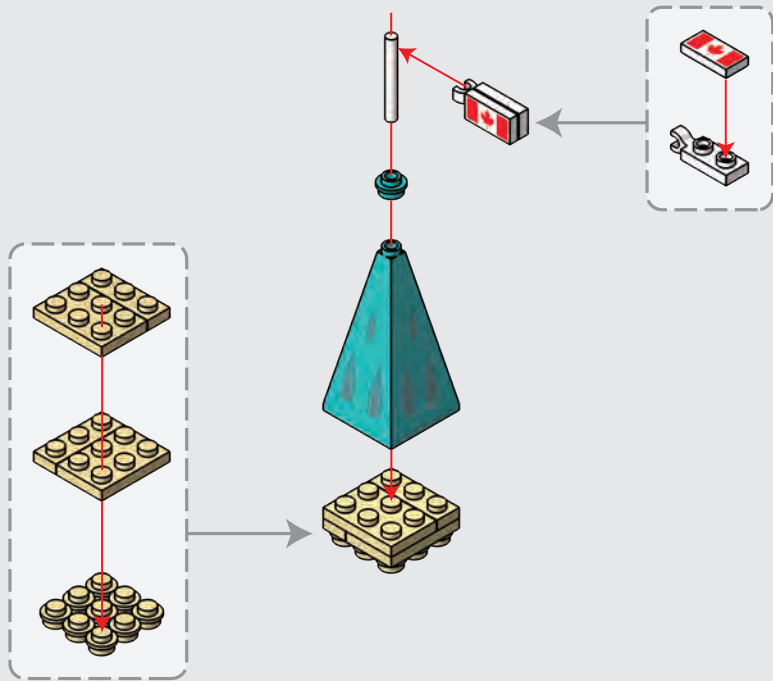
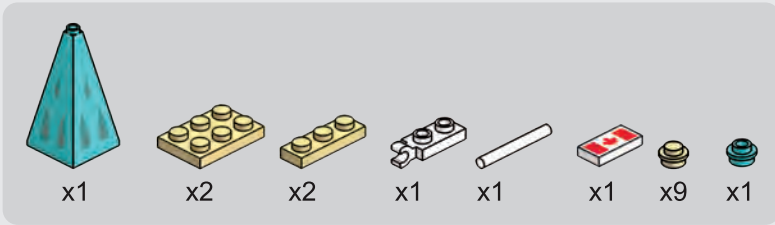

3-12

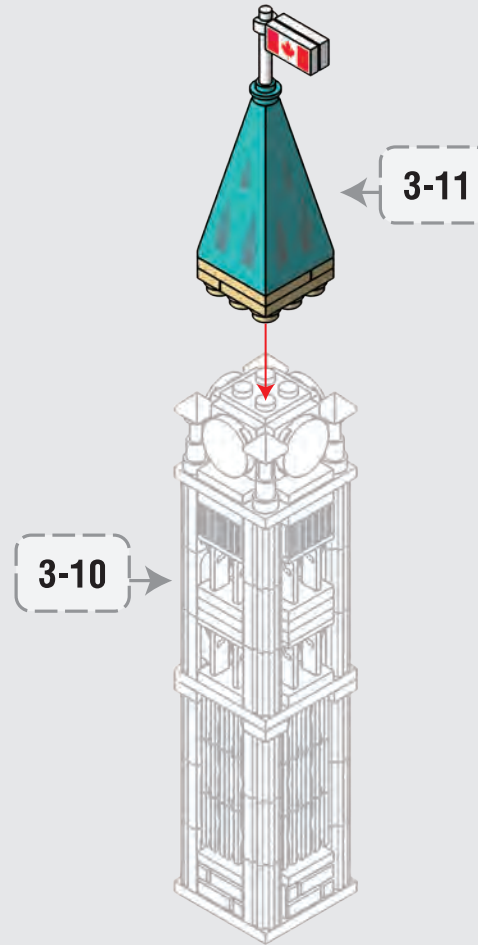



3-13

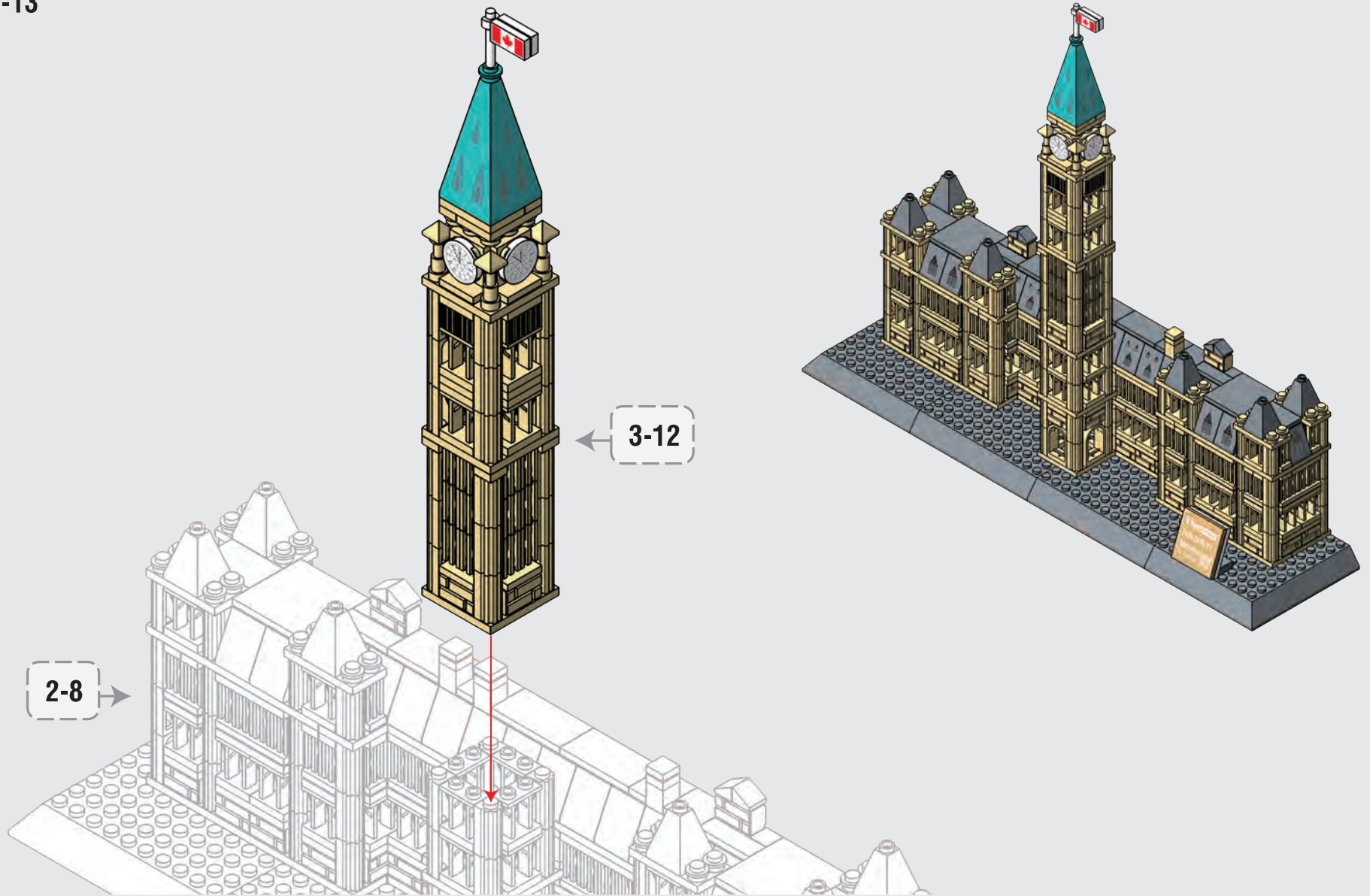

# PARLIAMENT BUILDINGS OF OTTAWA

## INTRODUCTION

Parliament Hill, colloquially known as The Hill, is an area of Crown land on the southern banks of the Ottawa River in downtown Ottawa, Ontario, Canada. Its Gothic revival suite of buildings is the home of the Parliament of Canada and has architectural elements of national symbolic importance. Parliament Hill attracts approximately 3 million visitors each year. Law enforcement on Parliament Hill and in the parliamentary precinct is the responsibility of the Parliamentary Protective Service. Originally the site of a military base in the 18th and early 19th centuries, development of the area into a governmental precinct began in 1859, after Queen Victoria chose Ottawa as the capital of the Province of Canada. Following a number of extensions to the parliament and departmental buildings and a fire in 1916 that destroyed the Centre Block, Parliament Hill took on its present form with the completion of the Peace Tower in 1927. Since 2002, an extensive \$1 billion renovation and rehabilitation project has been underway throughout all of the precinct's buildings; work is not expected to be complete until after 2028.

## ALSO AVAILABLE: AUSSI DISPONIBLES:



EMPIRE STATE  
BUILDING



THE CN TOWER  
LA TOUR DU CN

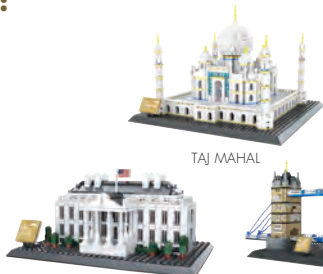

TAJ MAHAL



THE WHITE HOUSE  
LA MAISON-BLANCHE



THE TOWER BRIDGE  
TOWER BRIDGE



THE EIFFEL TOWER  
LA TOUR EIFFEL



THE BURJ AL ARAB HOTEL  
L'HÔTEL BURJ AL ARAB



LEANING TOWER OF PISA  
LA TOUR DE PISE



ELIZABETH TOWER  
TOUR ELIZABETH

# LE PARLEMENT D'OTTAWA

La Colline du Parlement, connue sous le nom anglais The Hill, est une zone de terres de la Couronne sur la rive sud de la rivière des Outaouais au centre-ville d'Ottawa, Ontario, Canada. Sa suite de bâtiments de style néogothique abrite le Parlement du Canada et possède des éléments architecturaux d'importance symbolique nationale. La Colline du Parlement attire environ 3 millions de visiteurs chaque année. L'application de la loi sur la Colline du Parlement et dans l'enceinte parlementaire est sous la responsabilité du Service de Protection Parlementaire. Originellement site d'une base militaire au XVIIIe et au début du XIXe siècle, le développement de la zone en une enceinte gouvernementale a commencé en 1859, après que la reine Victoria eut choisi Ottawa comme capitale de la province du Canada. Après plusieurs extensions du Parlement et des édifices départementaux et un incendie en 1916 qui a détruit l'édifice central, la Colline du Parlement a pris sa forme actuelle avec l'achèvement de la Tour de la Paix en 1927. Depuis 2002, un vaste projet de rénovation et de réhabilitation d'un milliard de dollars est en cours dans tous les bâtiments de l'enceinte; les travaux ne devraient pas être terminés avant 2028.

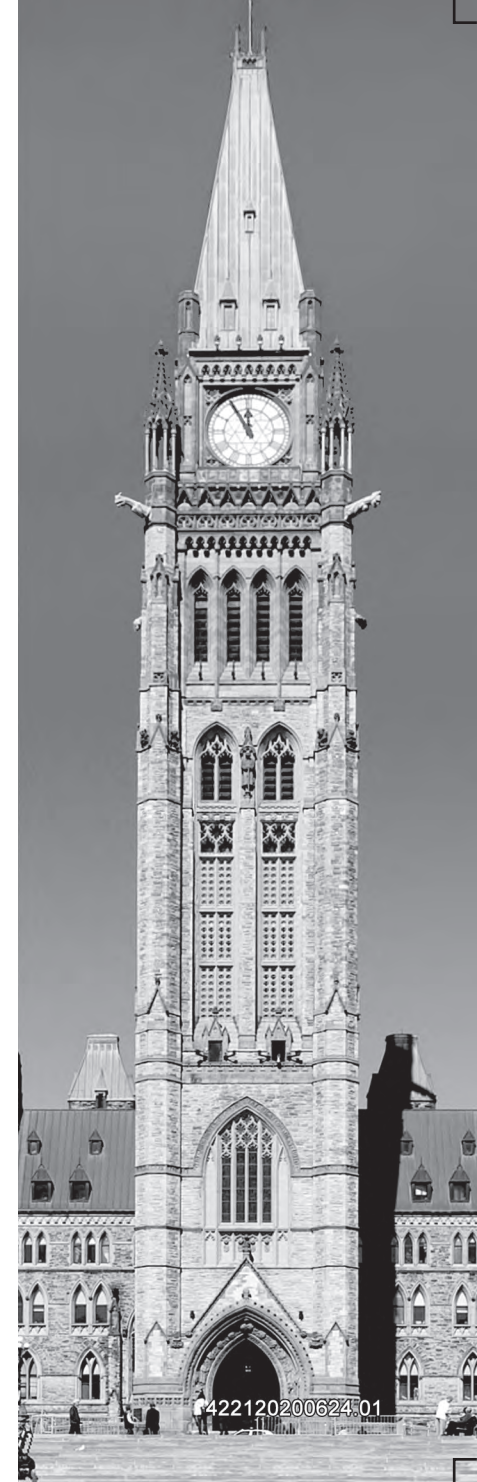

Manufactured & Distributed by:  
Manufacturé & Distribué par:



IMPORTS DRAGON®  
2515, avenue de la Renaissance,  
Brossard, Qc, Canada, J7H 1T9  
514.667.0623

info@importsdragon.com  
www.importsdragon.com

MADE IN CHINA /  
FABRIQUÉ EN CHINE

608 PCS  
DRAGONBLOK.COM



422120200624\_01